

WEO[®]

Montagehandleiding WEO[®] 35 & 60

V. 2-11-2022



| Raadpleeg bij gevelmontage altijd EU wetgeving & het lokale bouwbesluit |

| Locatie: Frankrijk |

Fiberdeck[®]

1 - PROFIELEN & TOEBEHOREN 03

- Product beschrijving
- Afmetingen
- Overzicht artikelen
- 10 essentiële punten

2 - VERTICALE MONTAGE WEO[®] 35 09

- Algemeen overzicht achterlatten
- Montage en afwerking
- Zetwerk
- Hoekprofiel
- Uitwendige hoek
- Inwendige hoek
- Kopse verbinding
- Horizontaal zetwerk
- Eind afwerking
- Verticaal zetwerk
- Vervangen van planken

3 - HORIZONTALE MONTAGE WEO[®] 35 20

- Algemeen overzicht achterlatten
- Montage en afwerking
- Zetwerk
- Hoekprofiel

- Uitwendige hoek
- Inwendige hoek
- Kopse verbinding
- Horizontaal zetwerk
- Eind afwerking
- Verticaal zetwerk
- Vervangen van planken

4 - INSTALLATIE VAN WEO[®] 35 OP HOUTSKELETBOUW 31

5 - INSTALLATIE VAN WEO[®] 35 OP METALEN FRAME 32

6 - MONTAGE VAN WEO[®] 60 34

- Algemeen overzicht achterlatten
- Montage en afwerking
- Vervangen van planken
- Mix van WEO[®] 35 & WEO[®] 60

Raadpleeg bij gevelmontage altijd de EU wetgeving en het lokaal geleedende bouwbesluit.





| Raadpleeg bij gevelmontage altijd EU wetgeving & het lokale bouwbesluit |
| Locatie: Frankrijk |

WEO® 35 & 60 zijn houtcomposiet planken met een rhombus profiel

De profielen zijn beide
horizontaal & verticaal te monteren

WEO® wordt gekenmerkt door de nieuwste generatie houtcomposieten, geproduceerd door middel van co-extrusie. De platen worden beschermd door een coating van polyethyleen die het gehele oppervlak bedekt en er zo voor zorgt dat geen vocht wordt geabsorbeerd. WEO® is bestand tegen vlekken en verkleuring.



PROFIELEN & TOEBEHOREN

1.1 - BESCHRIJVING VAN WEO®

WEO® 35 & 60 hebben een triple/double rhombus profiel en voldoen aan EN 15534. Het materiaal is samengesteld uit 50% houtvezels van houtverwerkingsfabrieken en 50% gerecycleerd polyethyleen. De planken hebben een geborsteld mat oppervlak met meerkleurige pigmentatie.

Het materiaal kan horizontaal of verticaal worden gemonteerd. WEO® 35 wordt ten alle tijden met gekleurde schroeven gemonteerd. WEO® 60 kan verticaal blind gemonteerd worden, horizontaal is de montage identiek aan WEO® 35.

Ventilatie is enorm belangrijk. Zorg daarom voor genoeg ruimte tussen planken onderling, de muur, zetwerk/hoekprofielen en het maaiveld.

Raadpleeg bij gevelmontage altijd de EU wetgeving en het lokaal geleedende bouwbesluit.

Brandklasse WEO® 35 - E

Brandklasse WEO® 60 - D

1.2 - AFMETINGEN

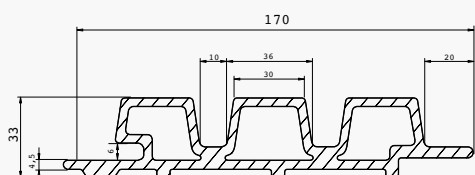

WEO® 35

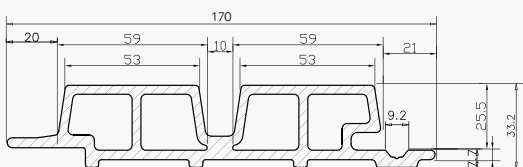

WEO® 60

Oppervlak (gebaseerd op de WB)	0,14 m ² /m ¹
Gewicht	2,3 kg/m ¹
Breedte	170 mm
Werkende breedte (WB)	140 mm
Lengte	3/3,6 m

	WEO® 35	WEO® 60
Rhombus delen per plank	3	2
Afmeting van rhombus (hoog)	36 mm	59 mm
Afmeting van rhombus (laag)	30 mm	53 mm
Golf diepte	21,5 mm	21,5 mm

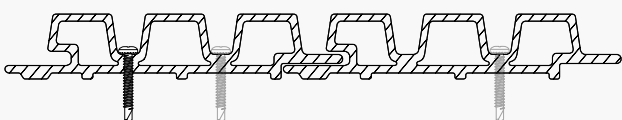

WEO® 35

Zowel VERTICAAL als HORIZNTAAL

Aantal schroeven /m ²	Aantal schroeven /m ¹
16	1,67 +2 per plank

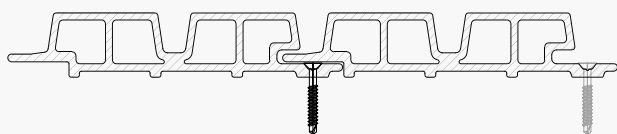

WEO® 60
VERTICAAL
Blinde montage

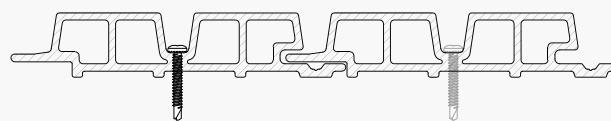

WEO® 60
HORIZNTAAL
Schroeven in het zicht

*WEO® 35 & 60 planken bevatten een tolerantie van +-3mm

1.3 - ARTIKEL OVERZICHT



WEO® 35

Composit gardenwall

33 x 170 x 3000/3600*mm

WB: 140mm | 2,3kg/m¹

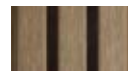

Teak*
Art. 2501



Dark Grey
Art. 2503

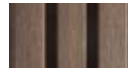

Ipé
Art. 2502



Light Grey
Art. 2504



WEO® 60

Composit geveldeel

33 x 170 x 3600mm

WB: 140mm | 2,3kg/m¹

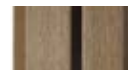

Teak
Art. 2664



Cedar
Art. 2666



Ipé
Art. 2665



Dark Grey
Art. 2667



WEO® 35 & 60

RVS schroeven
100 stuks + bit

4,2x38 mm | 2,0kg/doos



Teak



Dark Grey



Ipé



Cedar



Light Grey



RVS schroef WEO® 60
Voor blinde bevestiging

4.2 x 32mm | 500stk + bit | 1,2kg/doos

Art. 2668



WEO® 35 & 60

F-profiel
(per 2 stk)

65 x 80 x 3600 mm | 4 kg/stk



Teak
Art. 2429



Dark Grey
Art. 2432



Ipé
Art. 2430



Cedar
Art. 2687



Light Grey
Art. 2431

*RAL kleurcodes staan vermeld op pagina 8



1.4 - 10 essentiële punten



1 OPSLAG EN HANTERING

- > Het is noodzakelijk dat planken horizontaal worden opgeslagen.
- > Zorg dat het materiaal afgedekt is op de werkplaats.
- > Plaats geen andere materialen op de planken.
- > Verplaats planken één voor één of draag ze aan de uiteindes

2 GEREEDSCHAP

- > Afkort zaag
- > Water pas
- > Schroevendraaier met bit
(wordt meegeleverd met schroeven)



3 ACHTERCONSTRUCTIE

- > De achterlatten moeten minimaal 30x40mm zijn.
- > De achterlatten mogen maximaal 60cm uit elkaar geplaatst worden
- > Bij wildverband moet iedere 30cm een achterlat geplaatst worden

4 MAATWERK

- > Elke plank moet op maat gezaagd worden voor montage.
- > Zaagwerk moet zeer nauwkeurig worden uitgevoerd m.b.t. een nette kopse verbindingen (zie bovenstande foto)



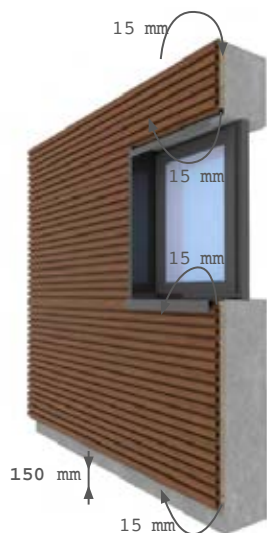

5 VENTILATIE

- > 150 mm boven maaiveld monteren.
- > 15mm afstand houden tot zetwerk, ramen, etc.
- > 20mm afstand tussen planken en muur.

6 BEVESTIGING OP HOUT

Met hulp van roestvrijstalen schroeven
(zie pagina 3).

- > Schroef met dezelfde kleur als de plank.
 - > Diameter schroefkop \varnothing 8.0 mm.
 - > Diameter schroefdraad \varnothing 4,2 mm.
 - > Lengte schroefdraad = 38 mm.
 - > zelfborende punt.
 - > Anti-lekkage inkeping onder de schroefkop.

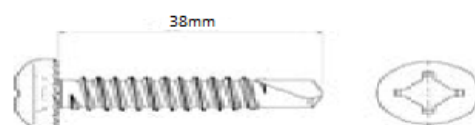
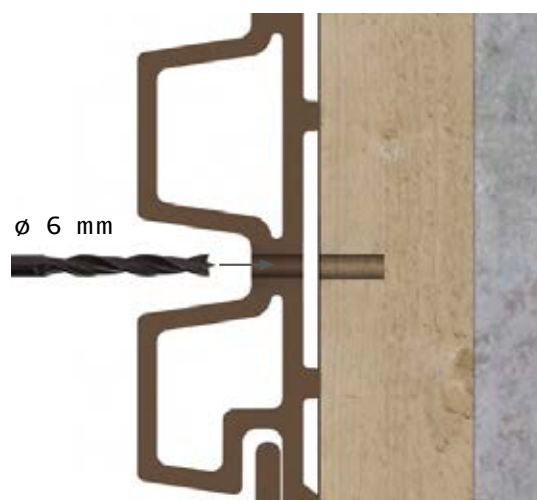

Stappenplan

- 1 - Voorboren met een houtboor \varnothing 6 mm.
- 2 - Plaats om de 60cm een schroef in de plank.
Voorzie WEO® 35 van 2 schroeven op de uiteindes.
Let op:
 - >Voorkom scheuren door de schroef niet te strak aan te draaien.
 - > Plaats de schroef op de uiteindes nooit minder dan 15mm van het eind van de plank.
- 3 - WEO® 60 kan verticaal blind gemonteerd worden door schroef (art. 2668) in de inkeping te zetten, zie foto rechts.

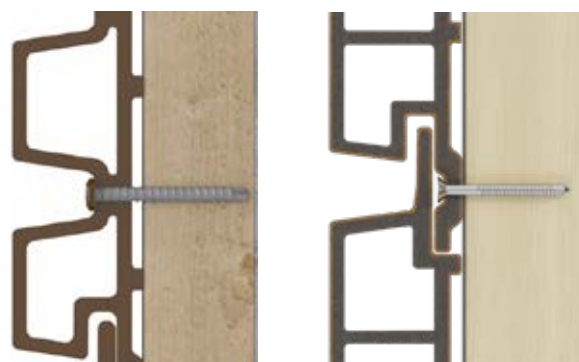

WEO® 35

WEO® 60

Horizontaal wordt geschroefd zoals WEO®35

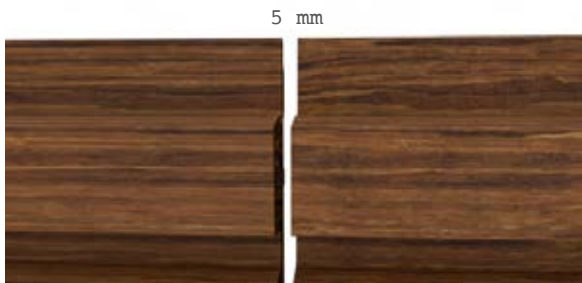
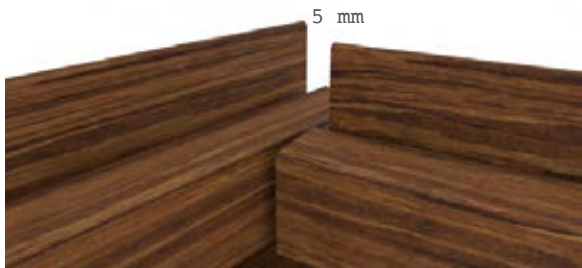

7 Detaillering

WEO® heeft een uitzettingscoëfficiënt van $1\text{mm}/\text{m}^1$ (voor een temperatuurgradiënt van 40°C)

Voorbeeld: in de ochtend (5°C) is een plank 3,6m en in de middag (40°C) is dezelfde plank 3,15 mm uitgezet.

Uitzetting in de breedte is verwaarloosbaar.

> Zorg ten alle tijden voor minimaal 5mm afstand aan eind van iedere plank.

8 Oriëntatie van de planken

Horizontale montage:

- > De tong markeert de bovenkant van de plank de groef moet beneden.
- > De onderste plank moet over de gehele lengte met 2 schroeven per 60cm worden gemonteerd.

Verticale montage:

- > Schroeven zoals beschreven bij punt 6.

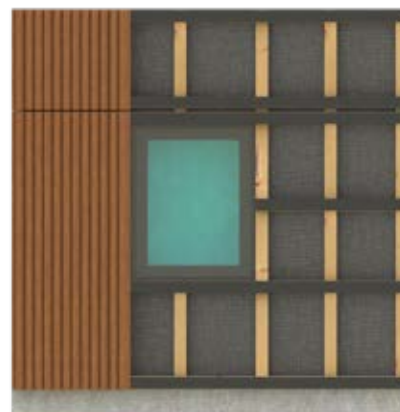

9 Afwerkingen

- > Wij bevelen het gebruik van gelakte aluminium profielen aan.
- > Alle noodzakelijke afwerkingsprofielen (binnen- en buitenhoeken, affimmeringspaneel, verticale of horizontale uitzetvoeg en meer) worden in deze montagehandleiding gedetailleerd beschreven.
- > Onderstaande tekeningen worden verstrekt volgens de kenmerken die in acht moeten genomen worden, en bepaalde elementen hebben variabele afmetingen die aan het werk moeten worden aangepast. De profielen moeten op verzoek worden vervaardigd door specialisten op het gebied van zetwerk.

Kleurcodes voor zetwerk op maat:

Teak: RAL 8024, Ipé: RAL 8028, Light Grey: RAL7006, Dark Grey: RAL 7022 Red Cedar: RAL 1011

10 ONDERHOUD

De beschermende coating van polyethyleen garandeert 20 jaar UV-bestendigheid zonder zichtbare verkleuring. Het materiaal kan na verloop van tijd vies worden. Reinigen kan worden met water en een mild schoonmaakmiddel, voorzichtig gebruik van een hogedrukreiniger is mogelijk.

2 - VERTICALE MONTAGE WEO® 35

2.1 - ALGEMEEN OVERZICHT ACHTERLATTEN



2 - VERTICALE MONTAGE WEO® 35

2.2 - MONTAGE EN AFWERKING VAN WEO® 35

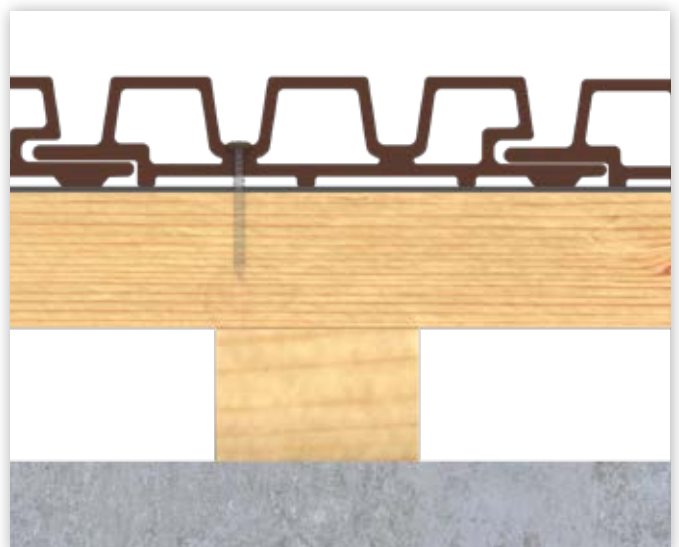
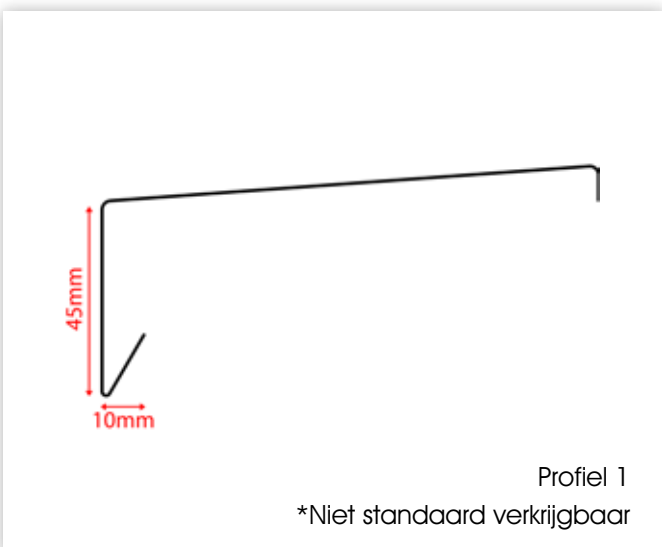
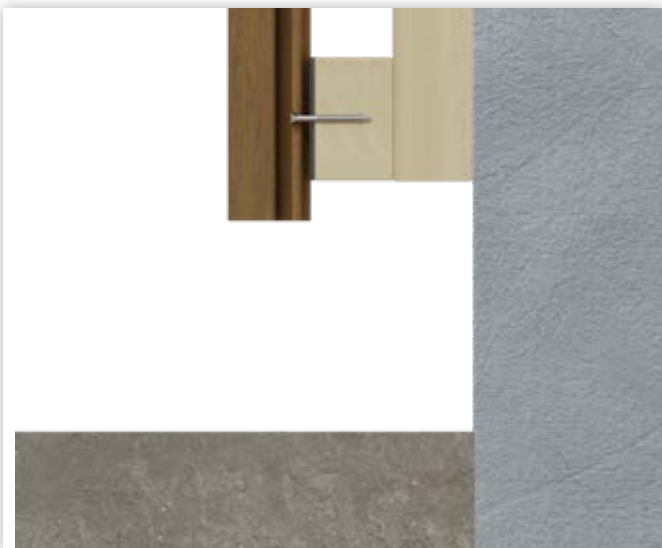
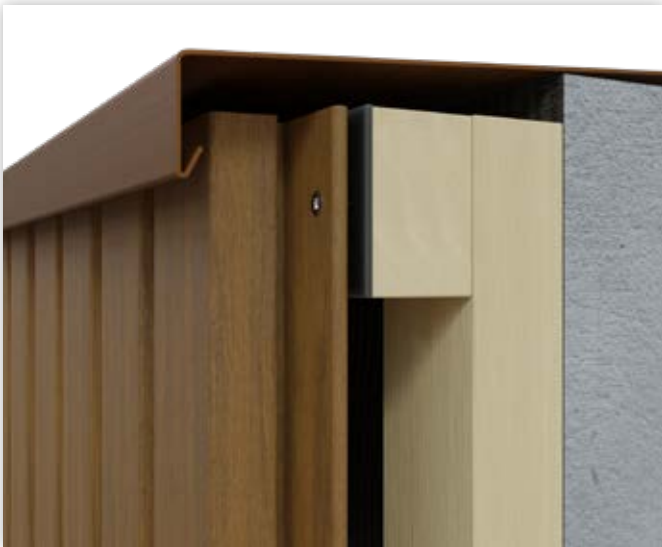

2 - VERTICALE MONTAGE WEO® 35

2.3 - ZETWERK

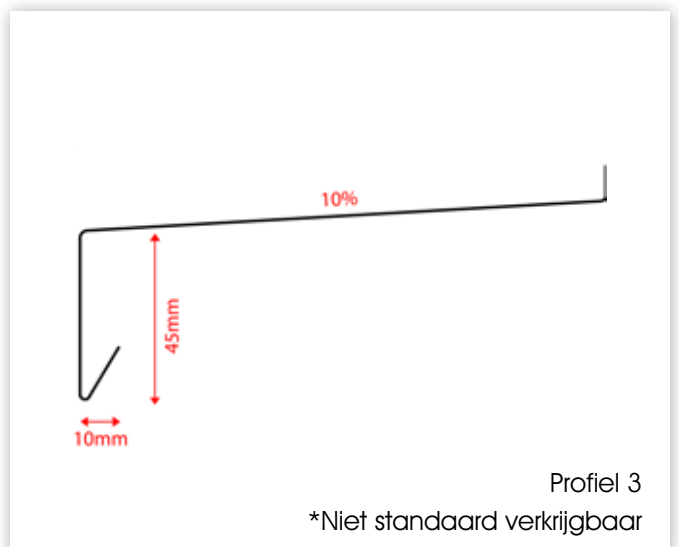
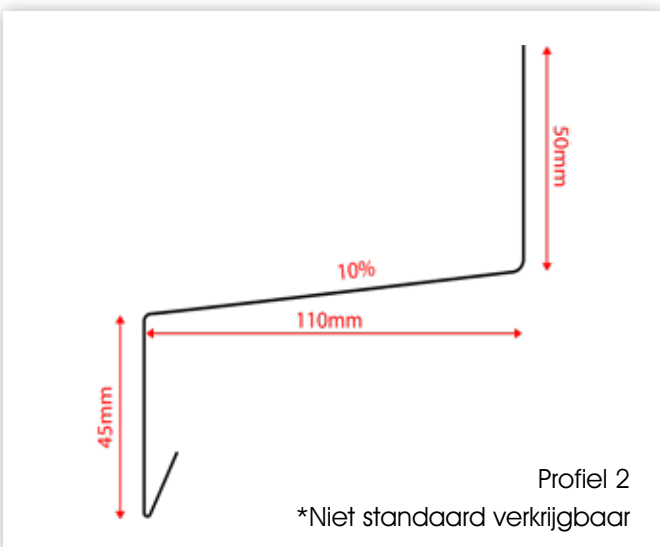
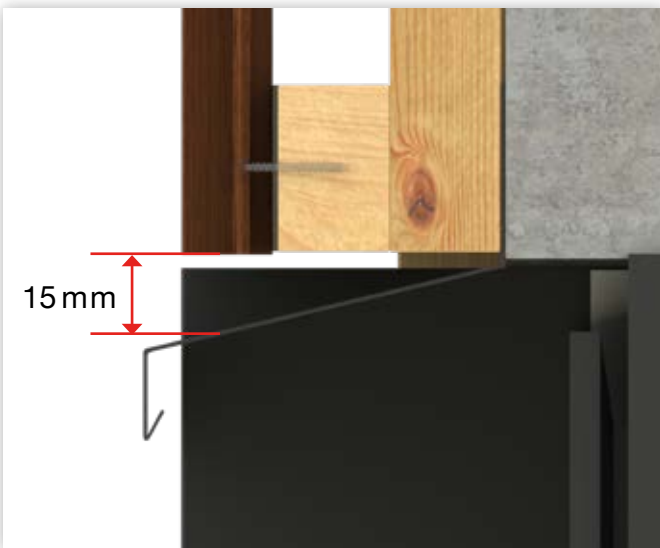
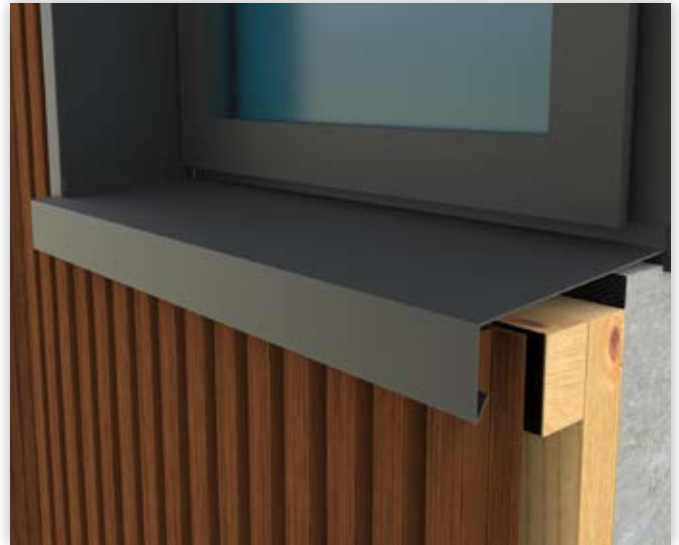
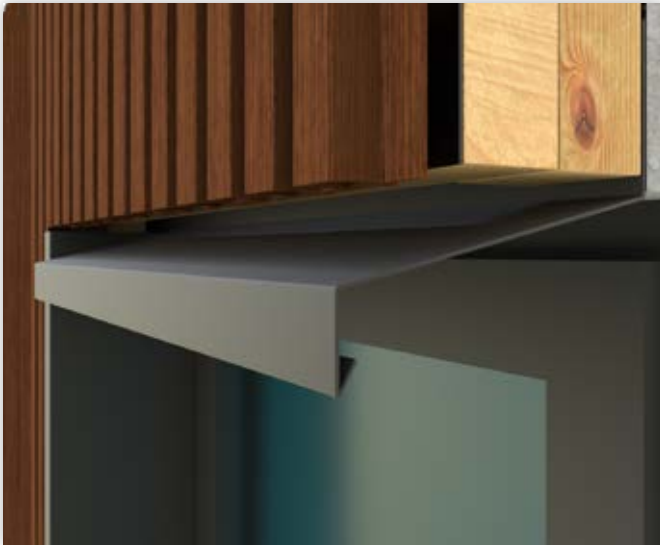

2 - VERTICALE MONTAGE WEO® 35

2.4 - HOEKPROFIEL

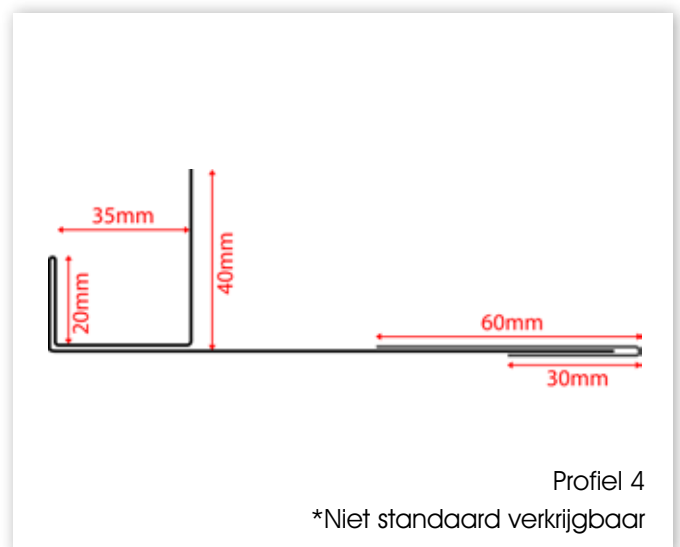

2 - VERTICALE MONTAGE WEO® 35

2.5 - UITWENDIGE HOEK MET STANDAARD F-PROFIEL

ZONDER PROFIEL

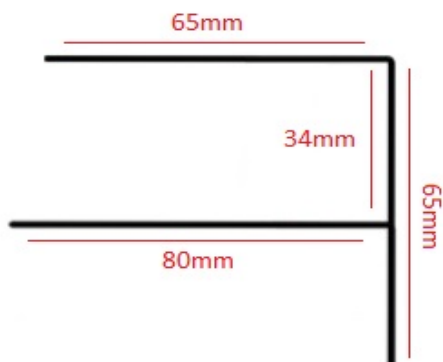
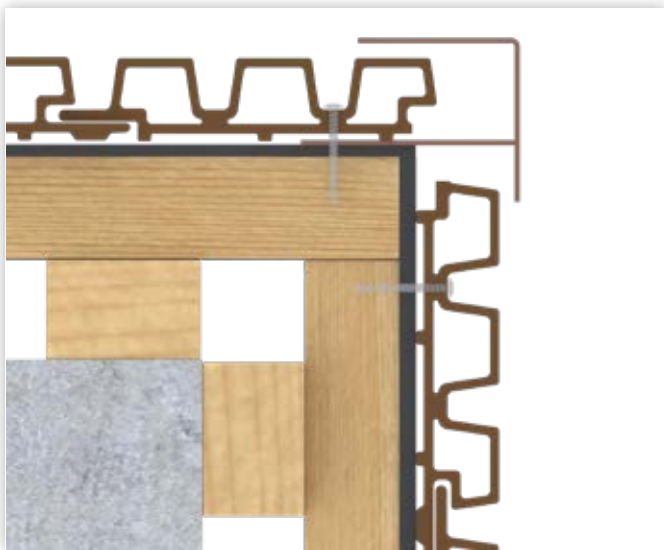
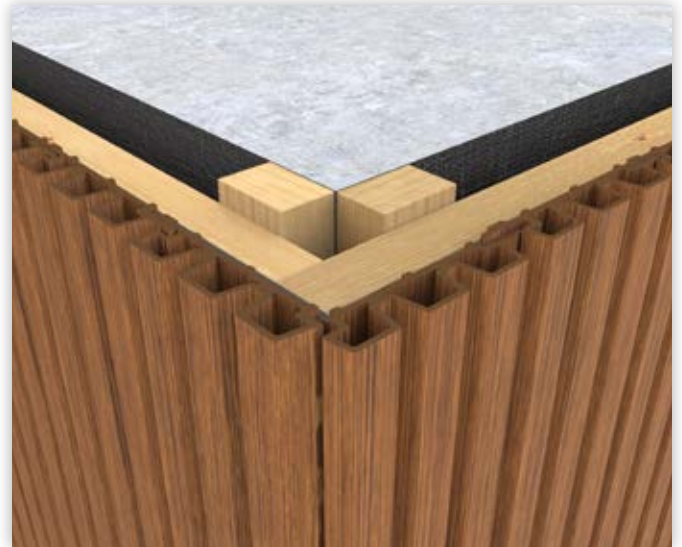
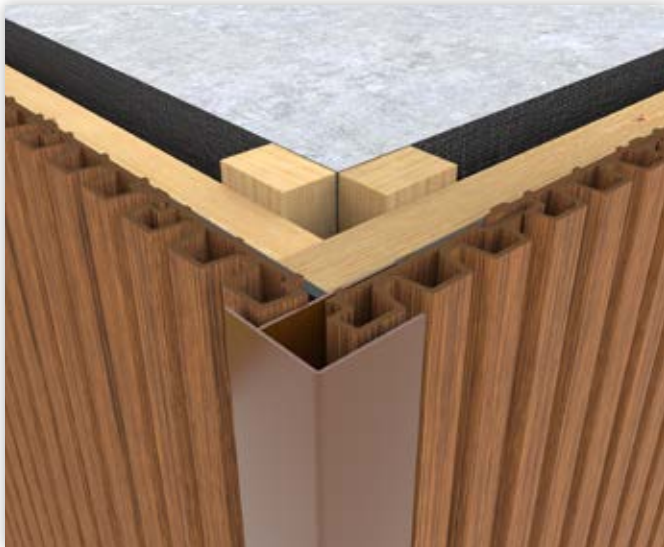

F-profiel: standaard verkrijgbaar, zie pagina 3

2 - VERTICALE MONTAGE WEO® 35

2.6 - INWENDIGE HOEK MET F-PROFIEL

ZONDER F-PROFIEL

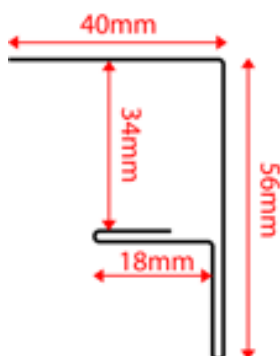
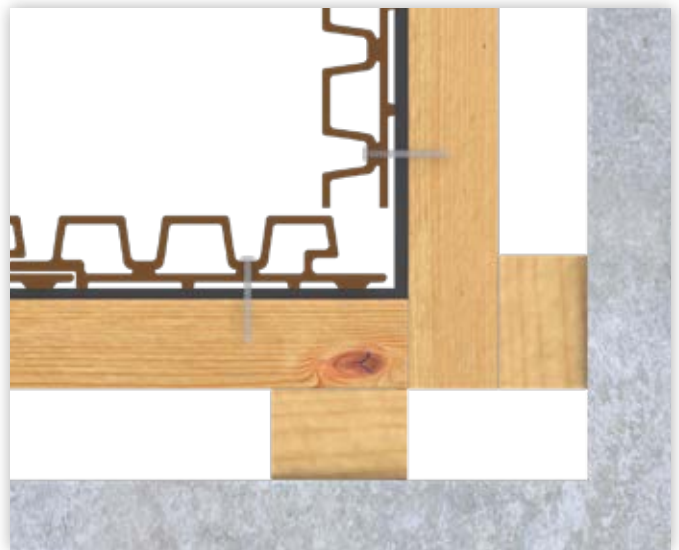
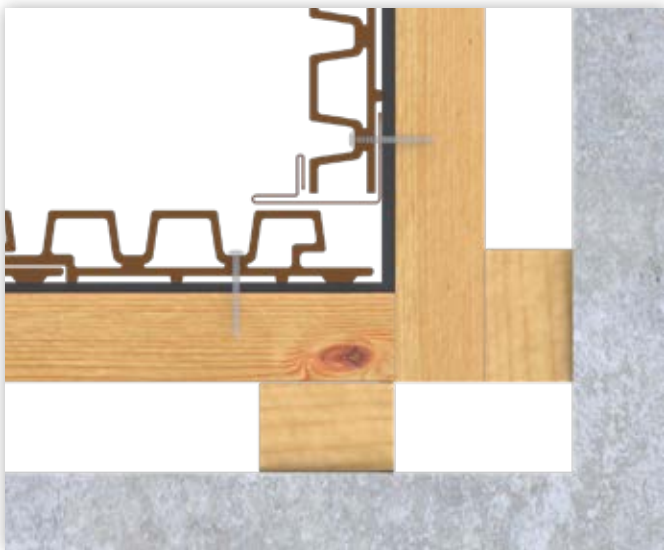

Profiel 5

*Niet standaard verkrijgbaar

2 - VERTICALE MONTAGE WEO® 35

2.7 - KOPSE VERBINDING

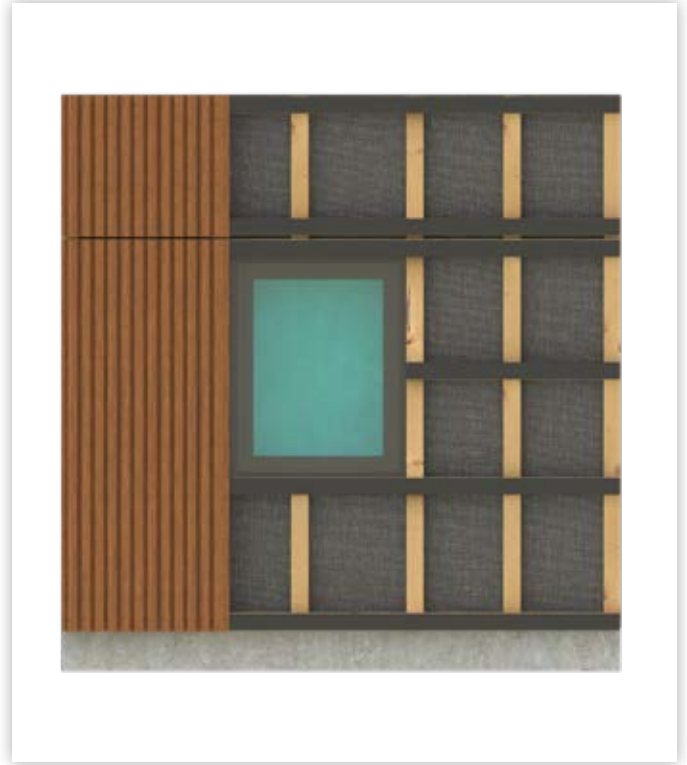

2 - VERTICALE MONTAGE WEO® 35

2.8 - VERTICAAL ZETWERK VOOR AFWATERING EN VENTILATIE

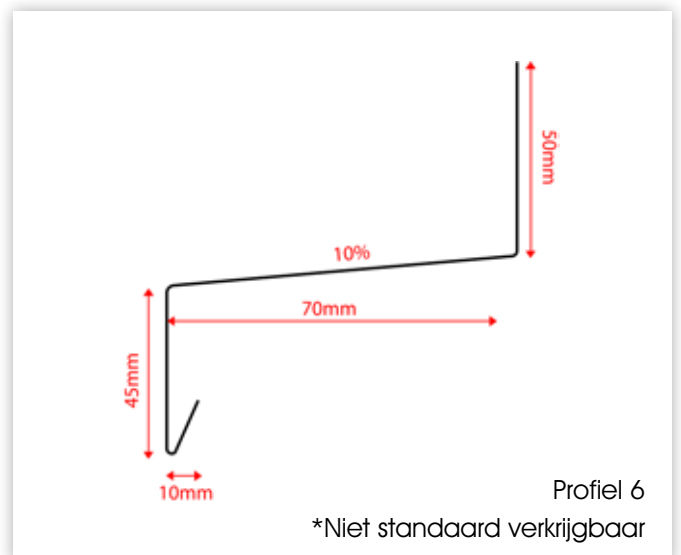
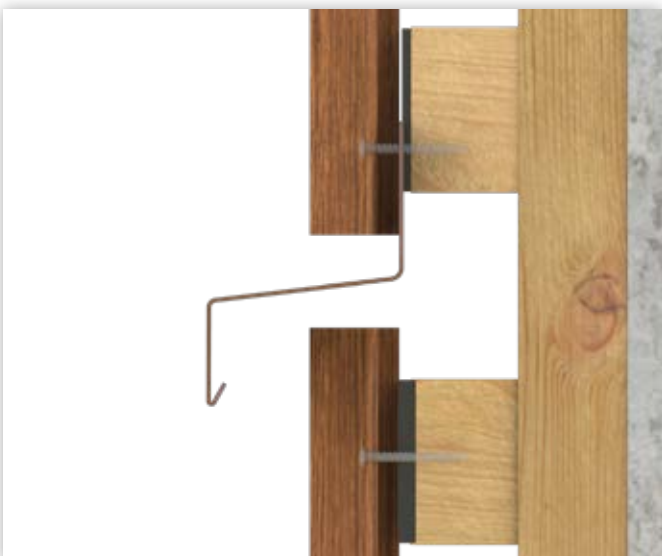

2 - VERTICALE MONTAGE WEO® 35

2.9 - EIND AFWERKING

MET VERKRIJGBAAR F-PROFIEL, ZIE PAGINA 3

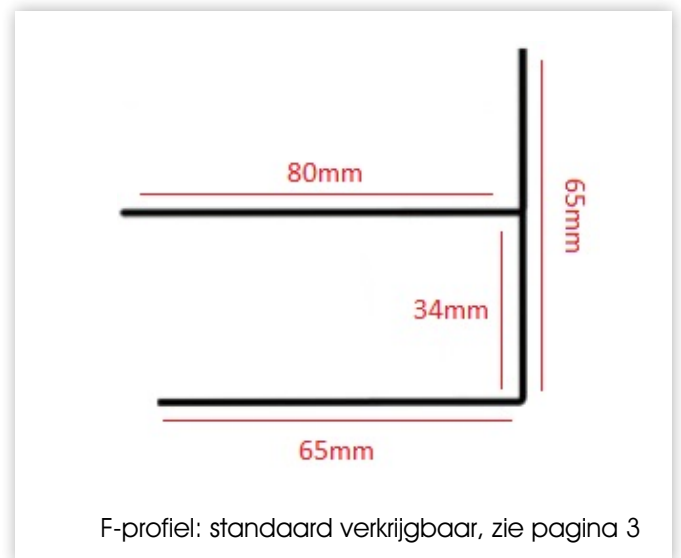
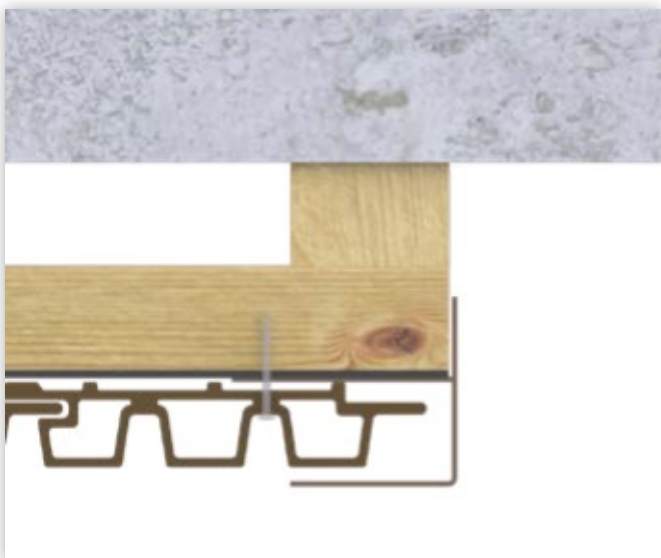
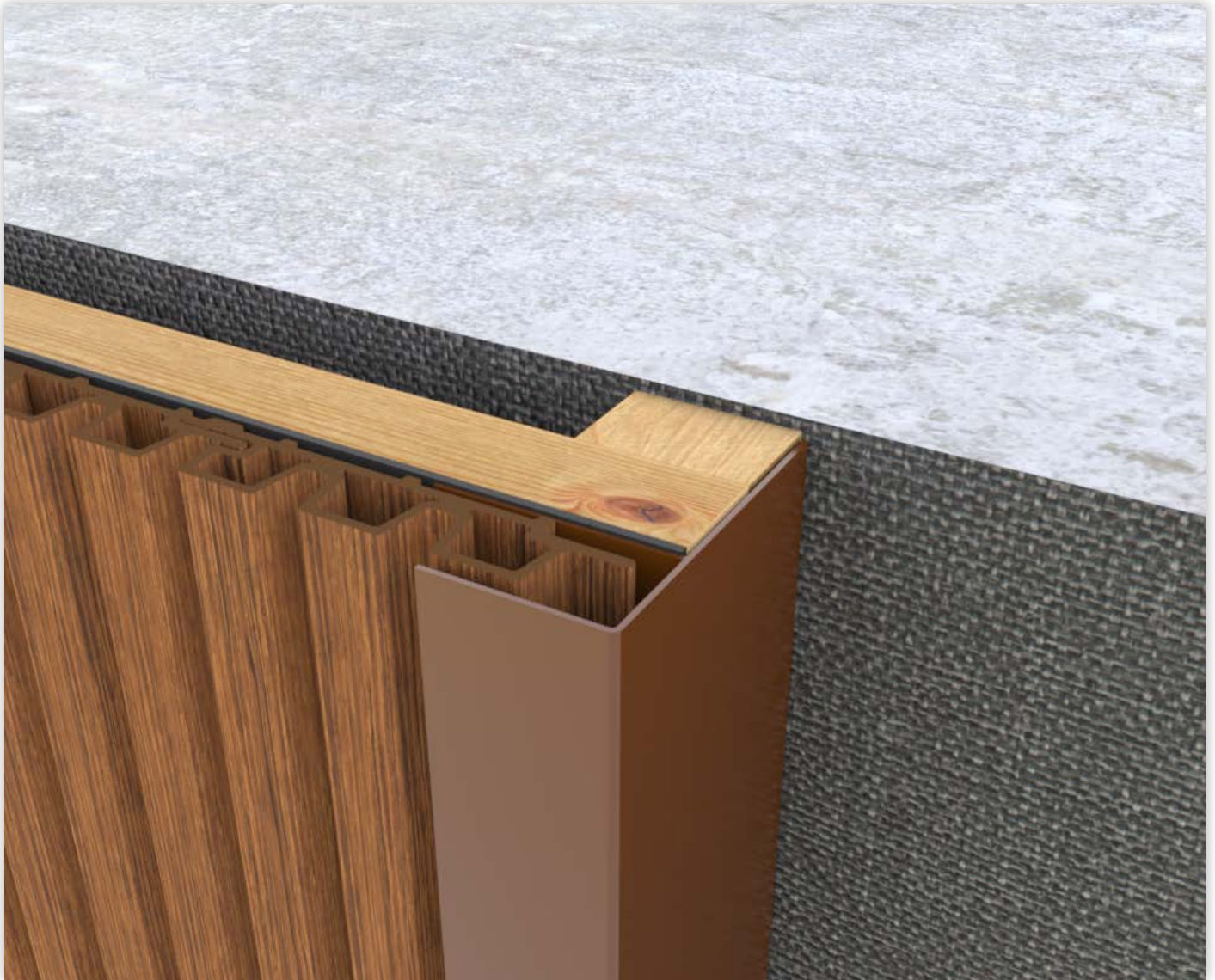

2 - VERTICALE MONTAGE WEO® 35

2.10 - HORIZONTAAL ZETWERK

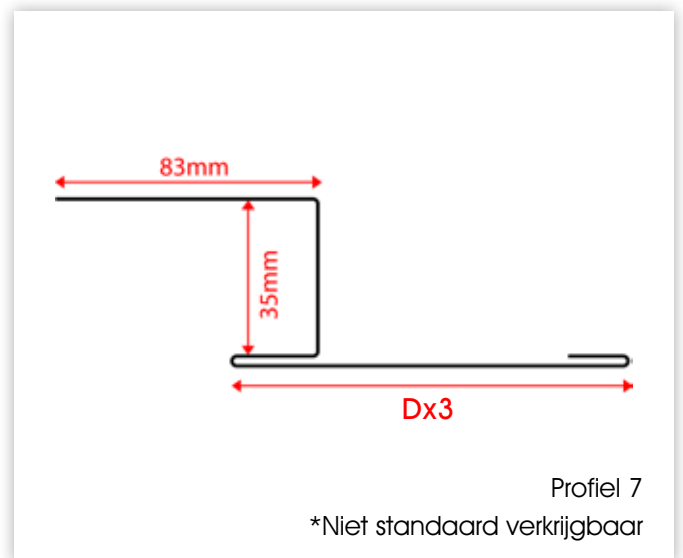
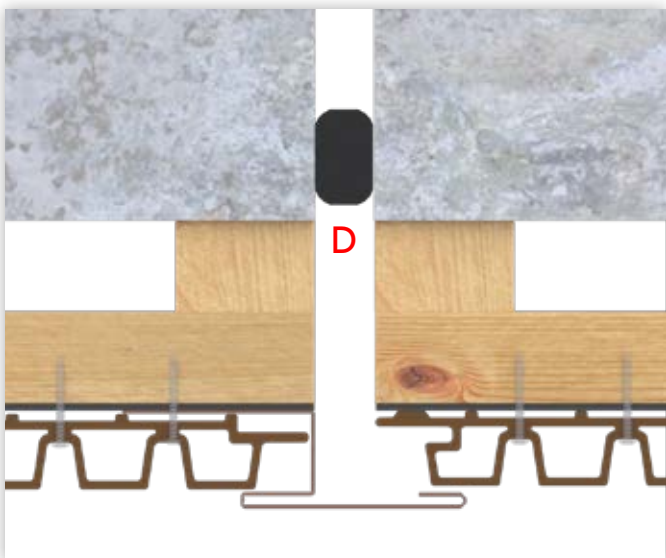

2 - VERTICALE MONTAGE WEO® 35

2.11 - VERVANGEN VAN PLANKEN

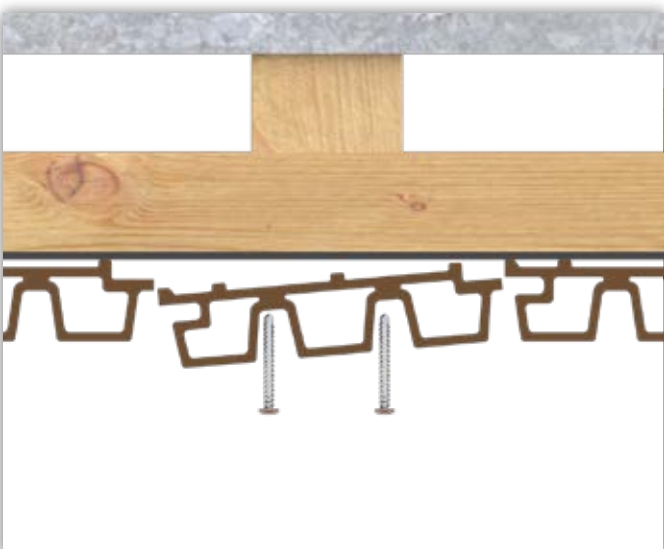
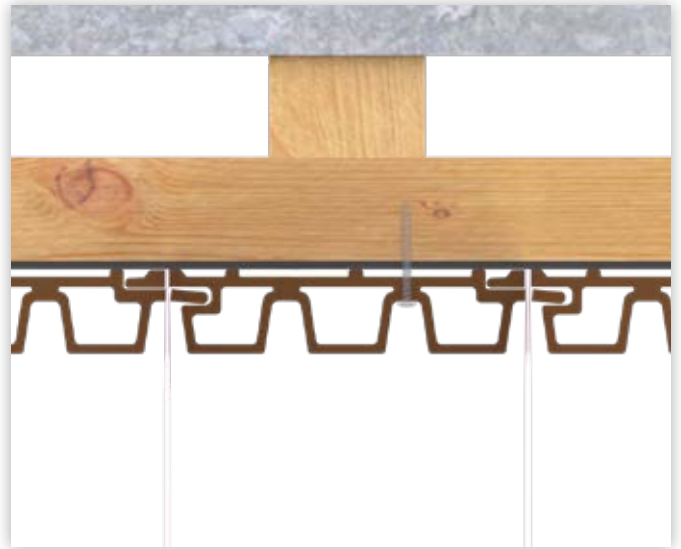

3 - HORIZONTALE MONTAGE WEO® 35

3.1 - ALGEMEEN OVERZICHT ACHTERLATTEN



MET ISOLATIEMATERIAAL

ZONDER ISOLATIEMATERIAAL

3 - HORIZONTALE MONTAGE WEO® 35

3.2 - MONTAGE EN AFWERKING WEO® 35

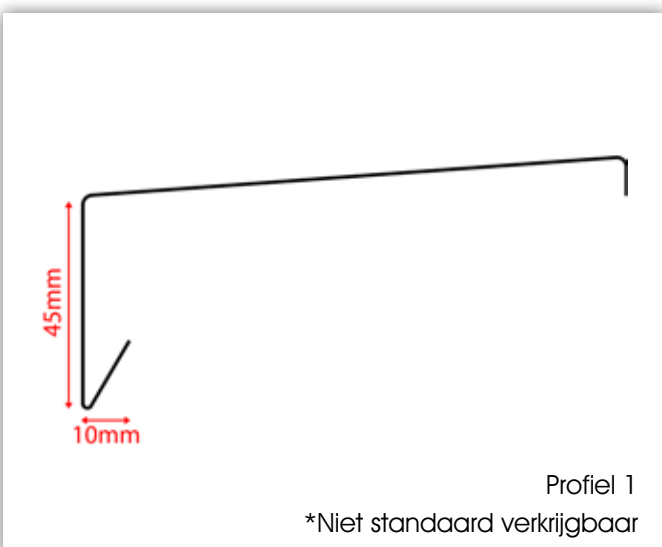
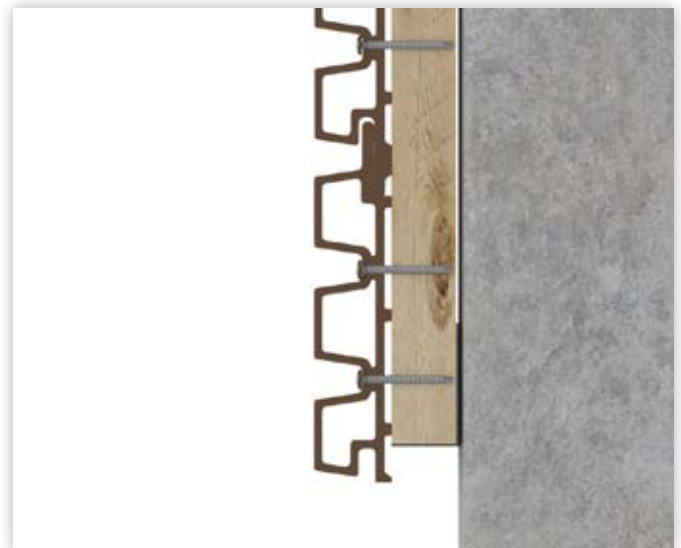
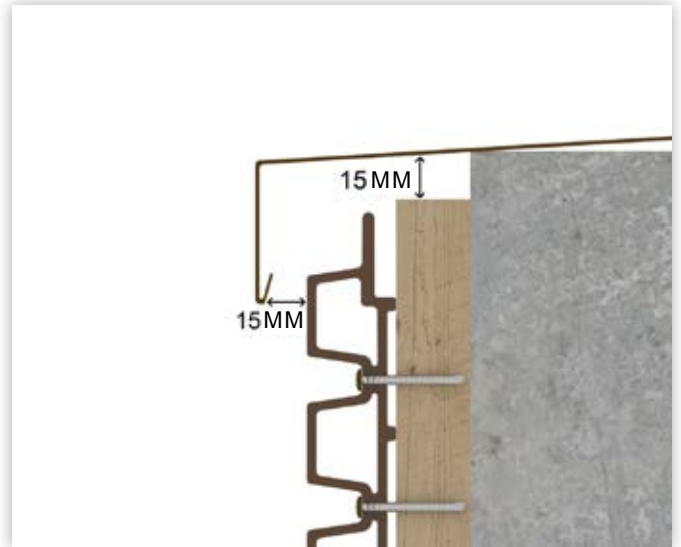
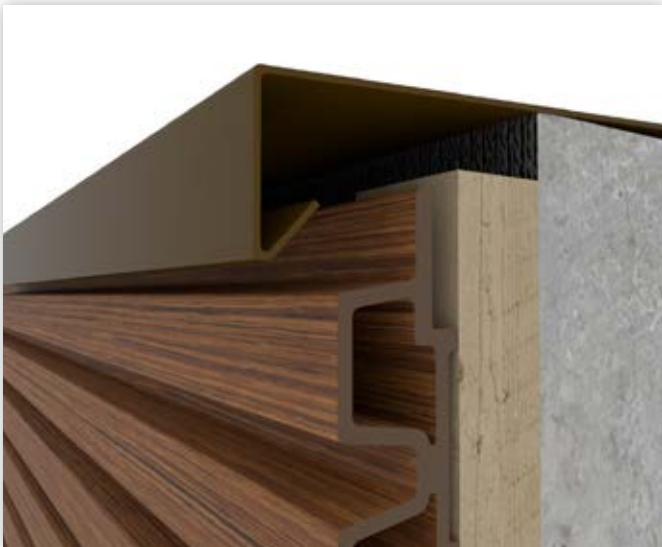

3 - HORIZONTALE MONTAGE WEO® 35

3.3 - ZETWERK

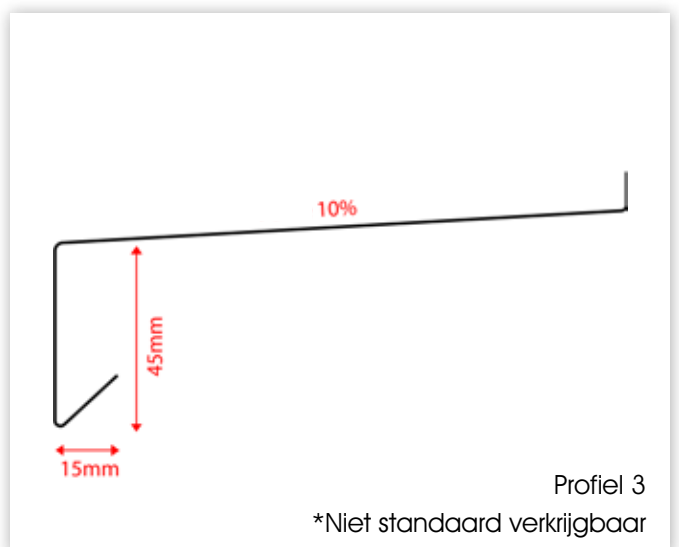
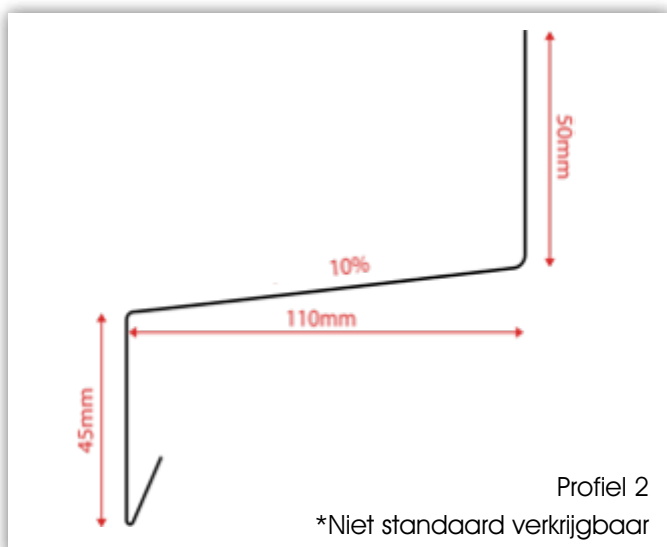

3 - HORIZONTALE MONTAGE WEO® 35

3.4 - HOEKPROFIEL

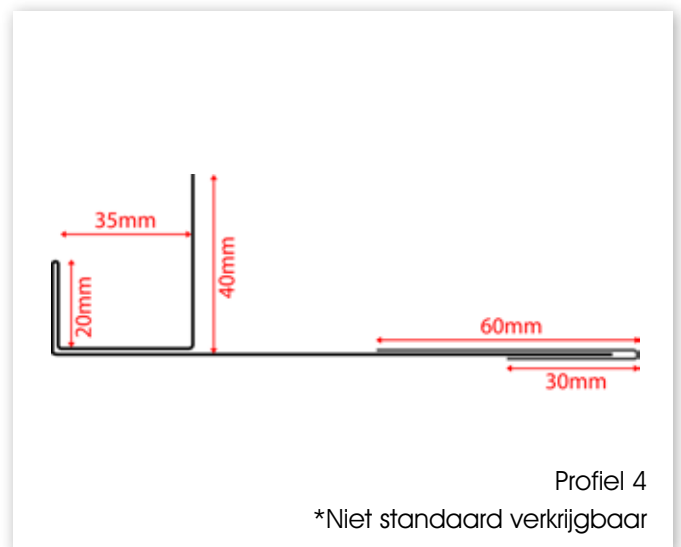
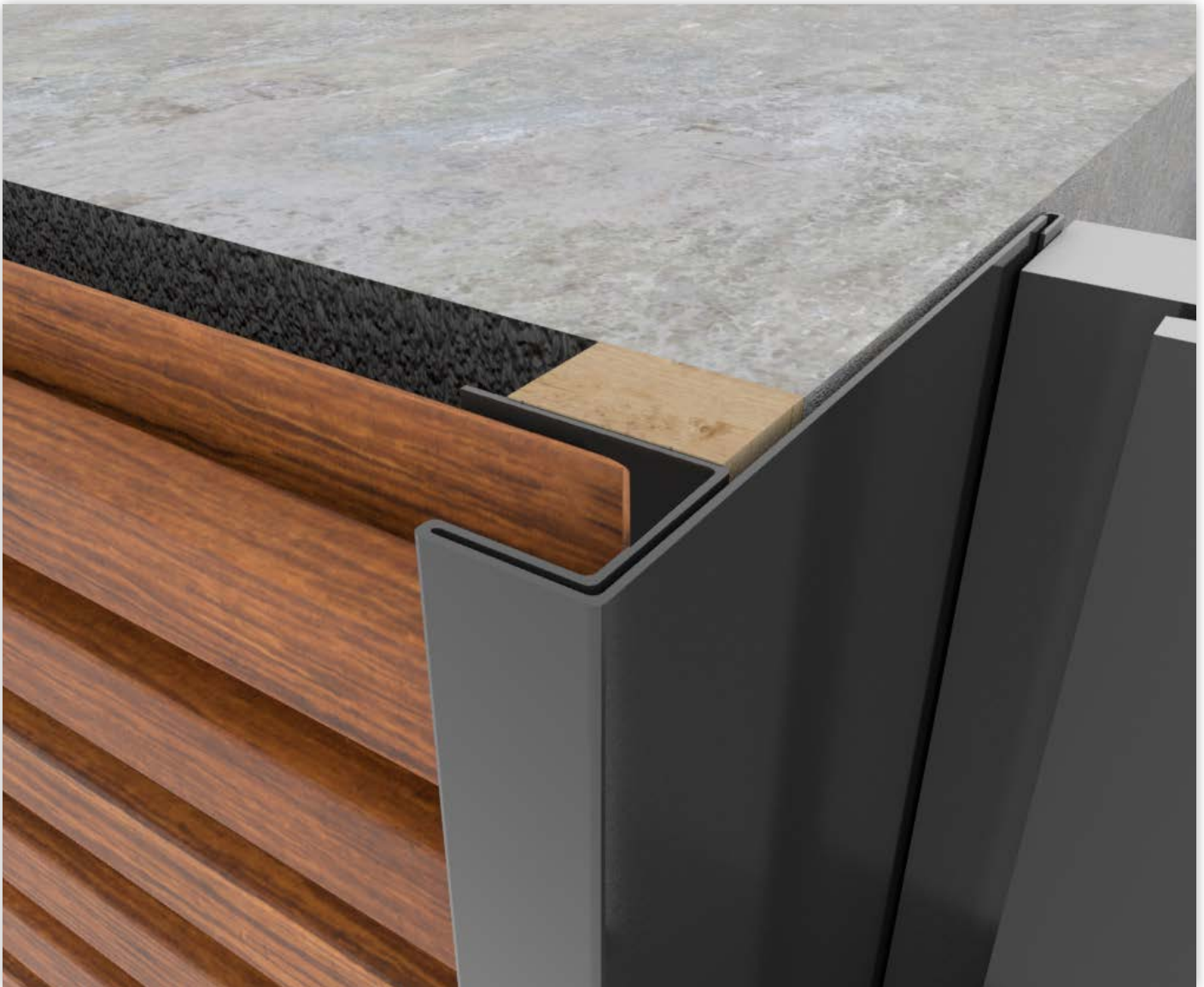

3 - HORIZONTALE MONTAGE WEO® 35

3.5 - UITWENDIGE HOEK MET VERKRIJGBAAR F-PROFIEL, ZIE PAGINA 3

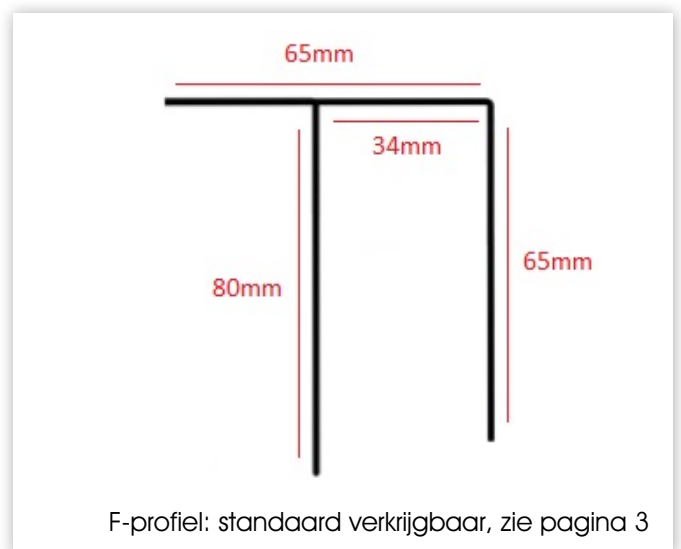
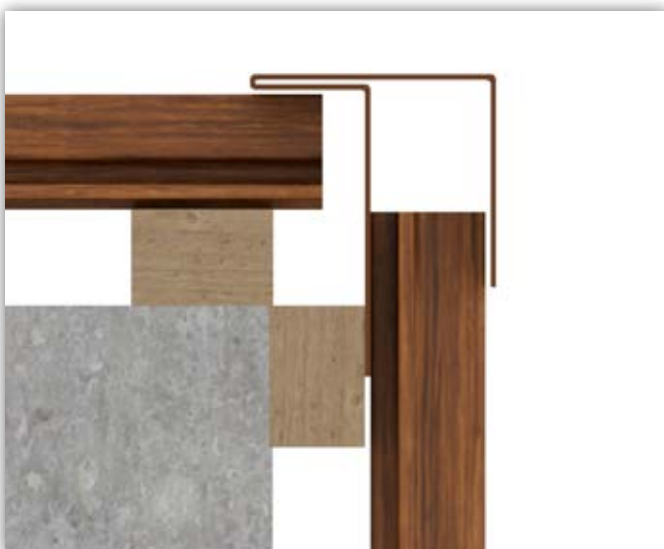
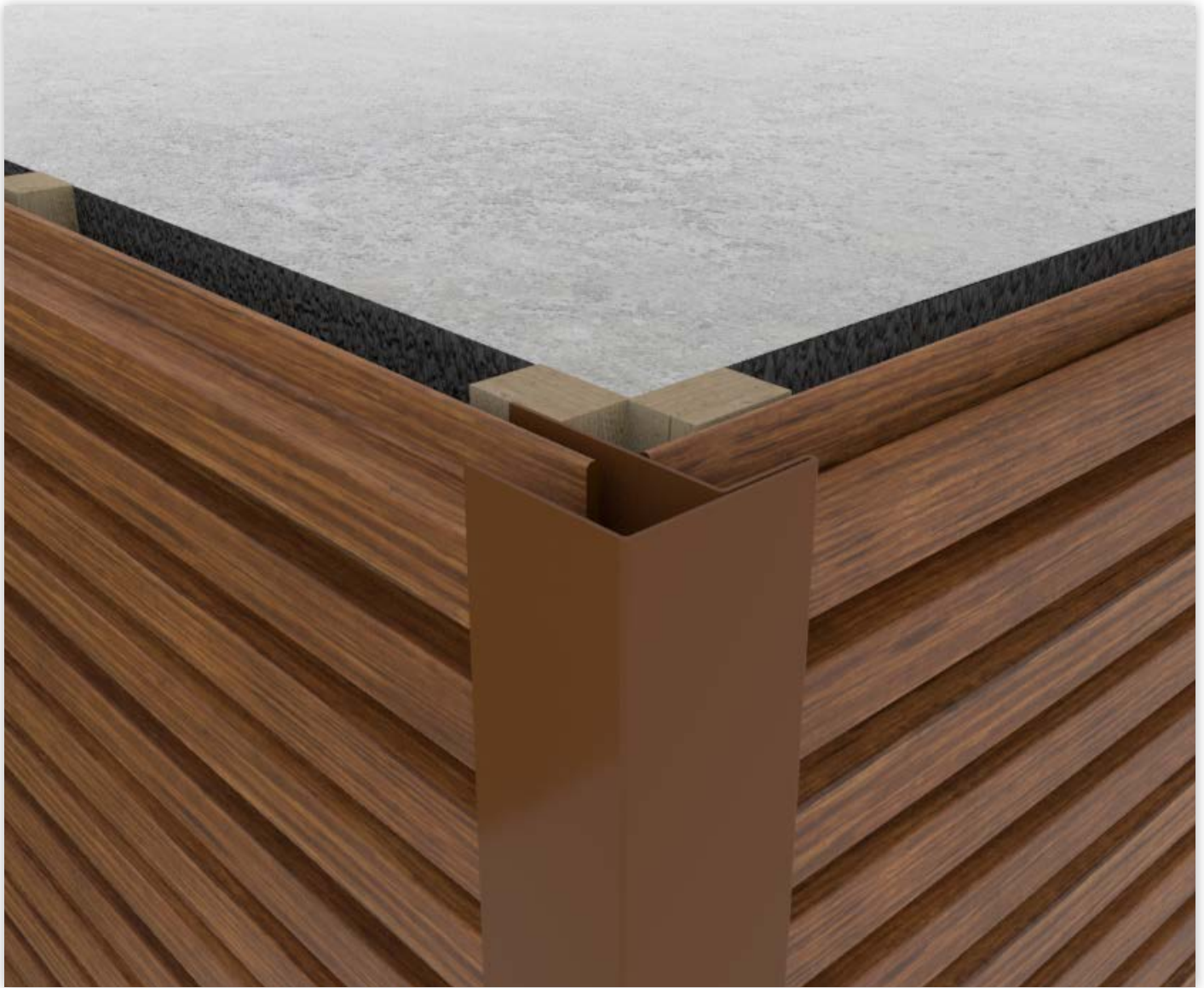

3 - HORIZONTALE MONTAGE WEO® 35

3.6 - INWENDIGE HOEK

MET F-PROFIEL

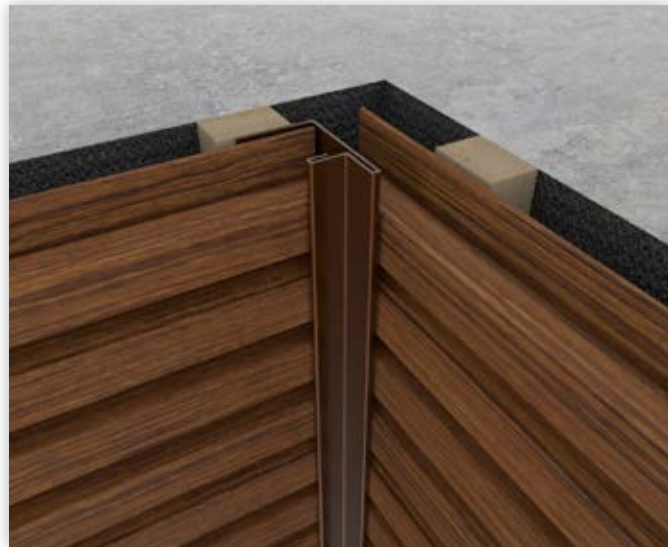

ZONDER F-PROFIEL

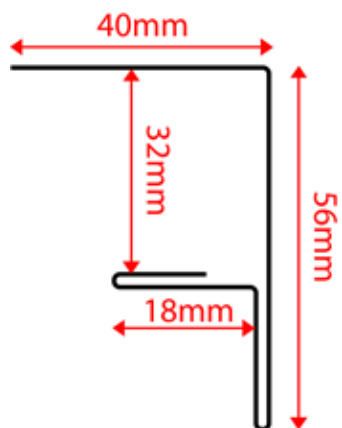
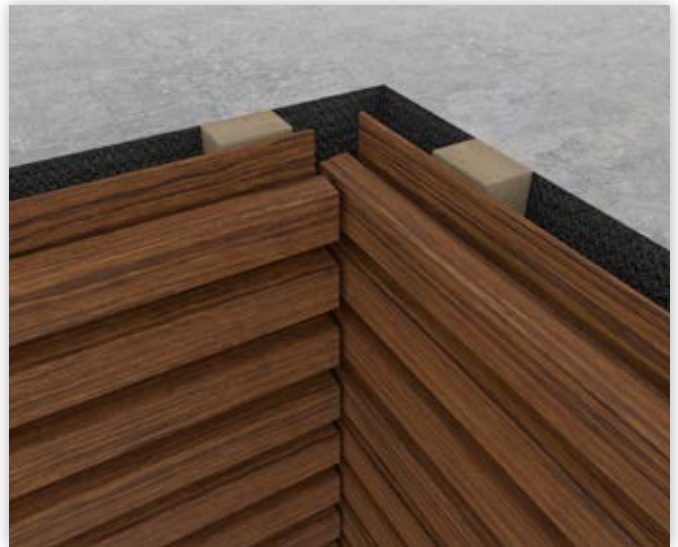

Profiel 5

*Niet standaard verkrijgbaar

3 - HORIZONTALE MONTAGE WEO® 35

3.7 - KOPSE VERBINDING

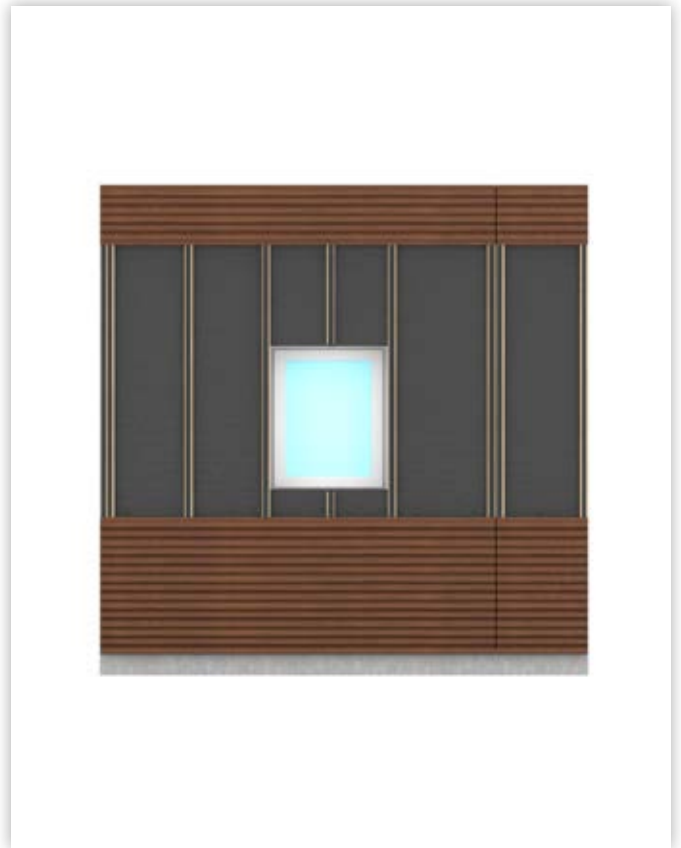

* zorg voor >5mm afstand

3 - HORIZONTALE MONTAGE WEO® 35

3.8 - HORIZONTAAL ZETWERK VOOR AFWATERING EN VENTILATIE

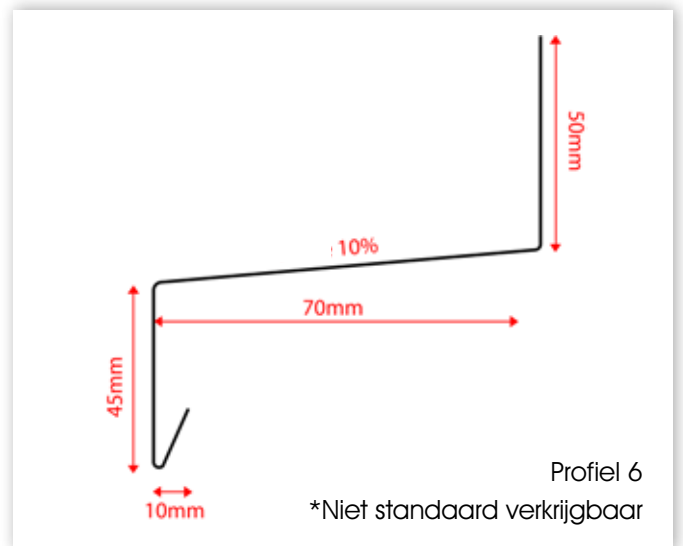
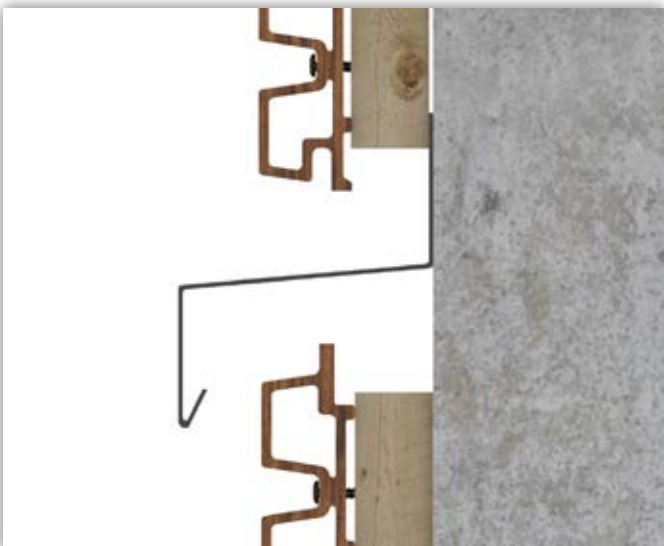

3 - HORIZONTALE MONTAGE WEO® 35

3.9 - EIND AFWERKING

MET VERKRIJGBAAR F-PROFIEL, ZIE PAGINA 3

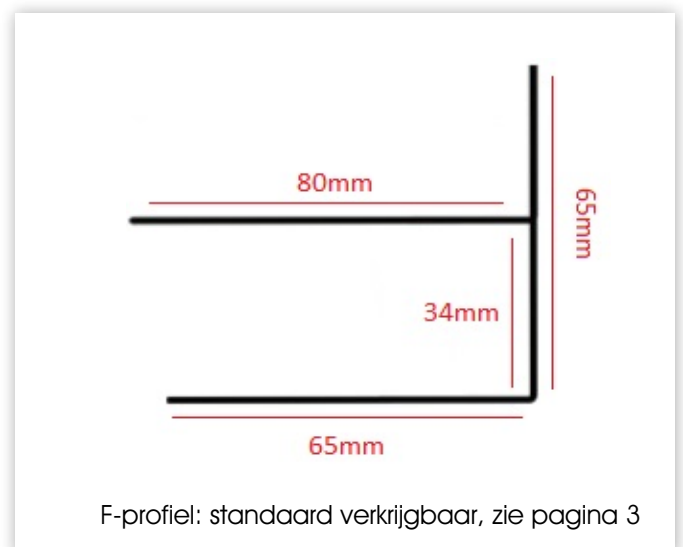
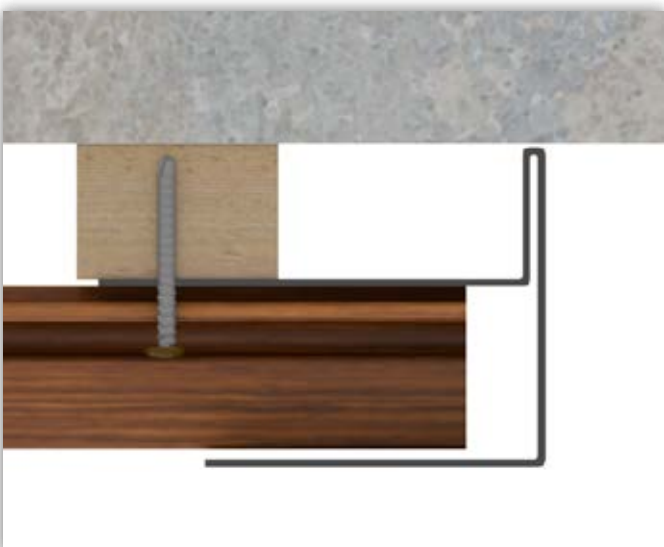
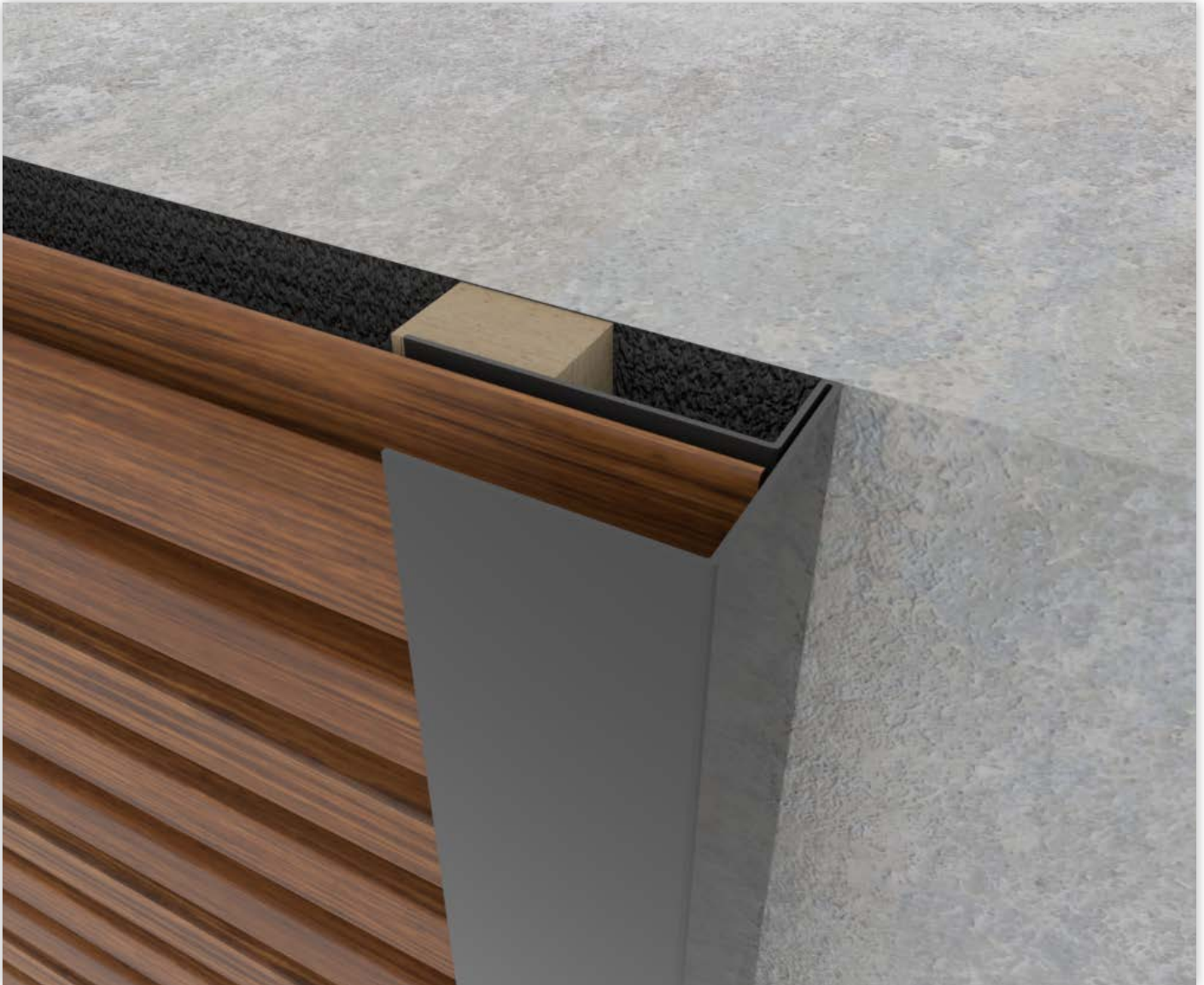

3 - HORIZONTALE MONTAGE WEO® 35

3.10 - VERTICAAL ZETWERK

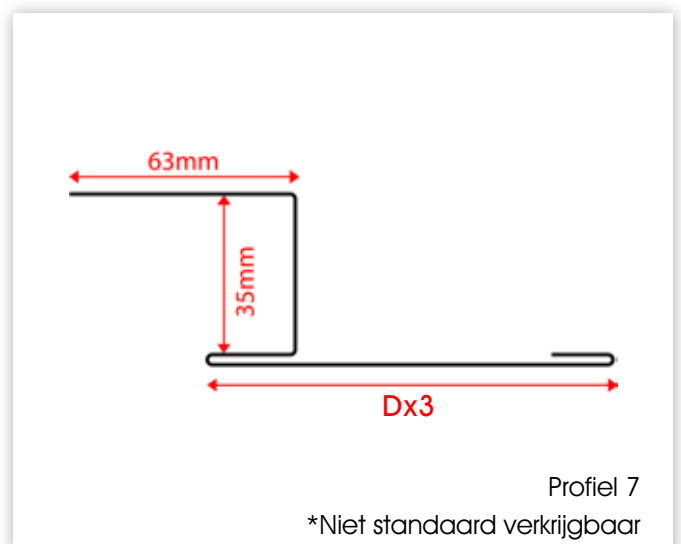
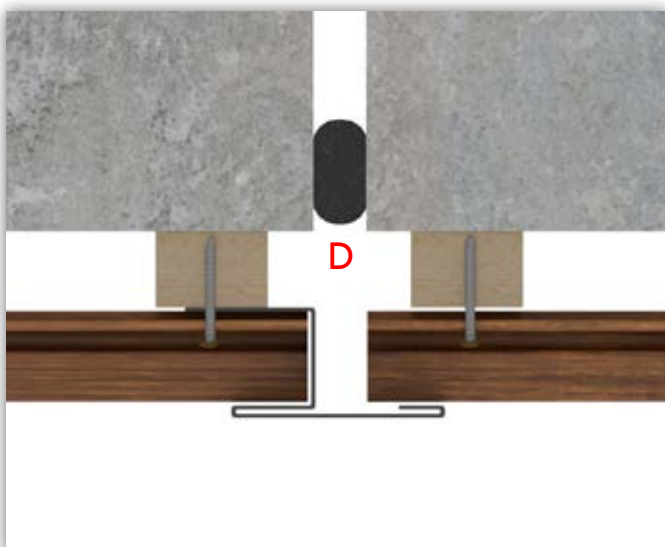
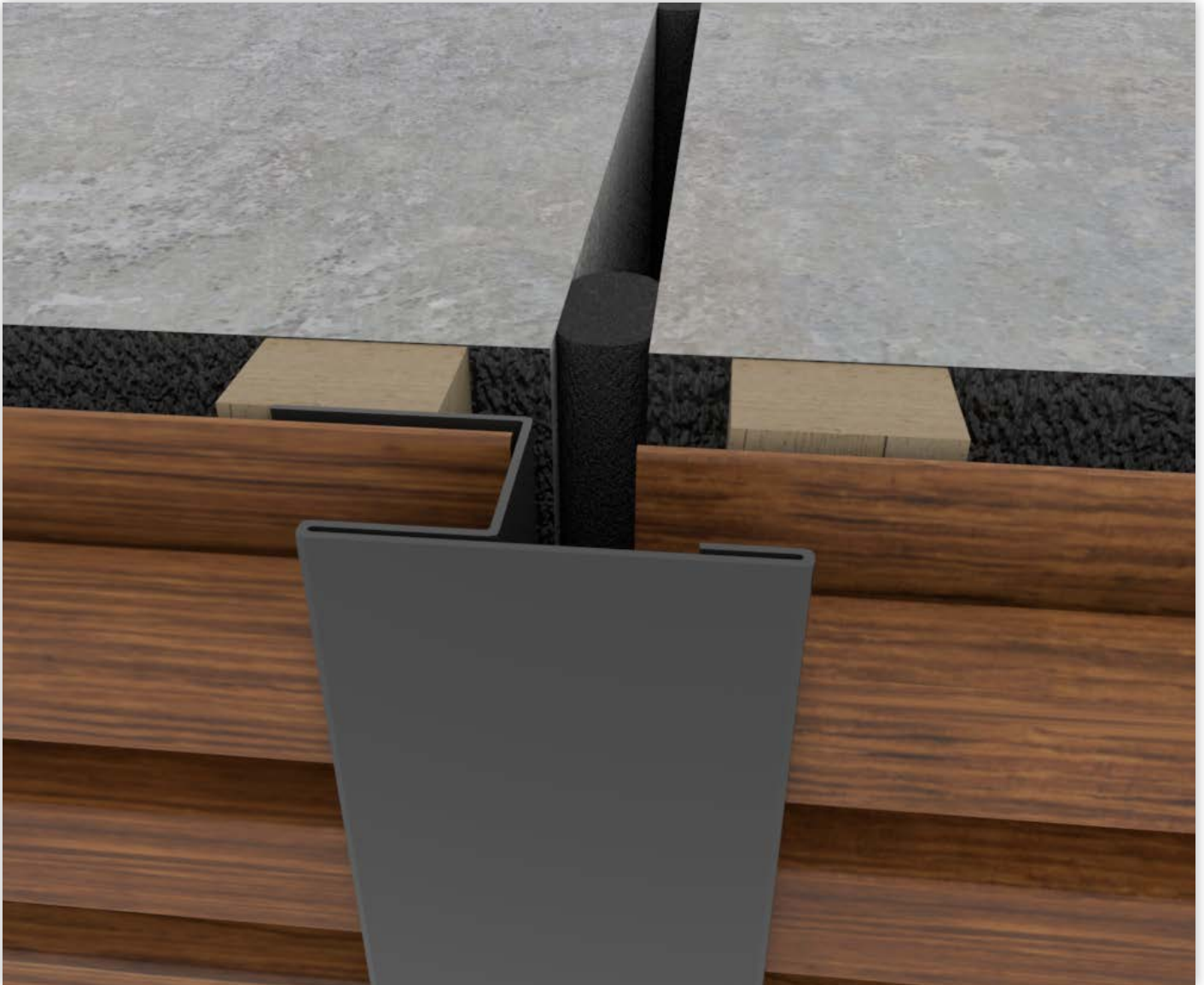

3 - HORIZONTALE MONTAGE WEO® 35

3.11 - VERVANGEN VAN PLANKEN

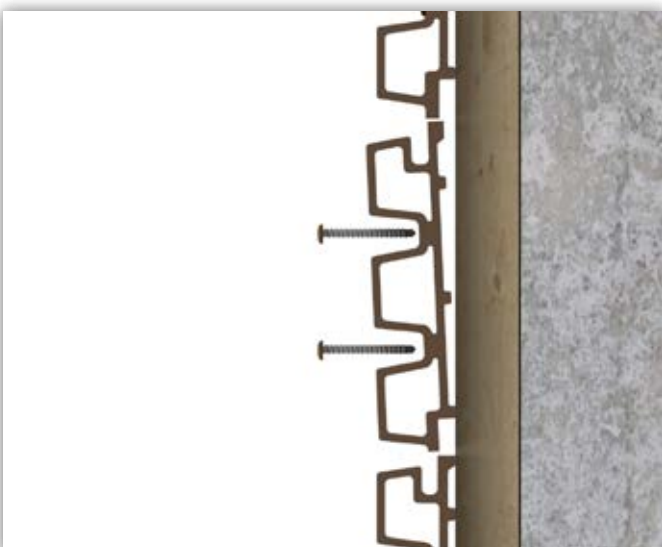
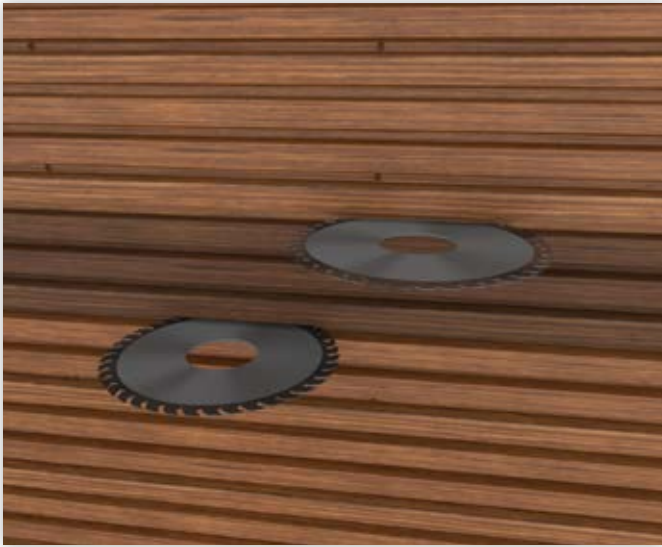

4 - INSTALLATIE VAN WEO 35® OP HOUTSKELETBOUW

4.1 - HORIZONTAAL

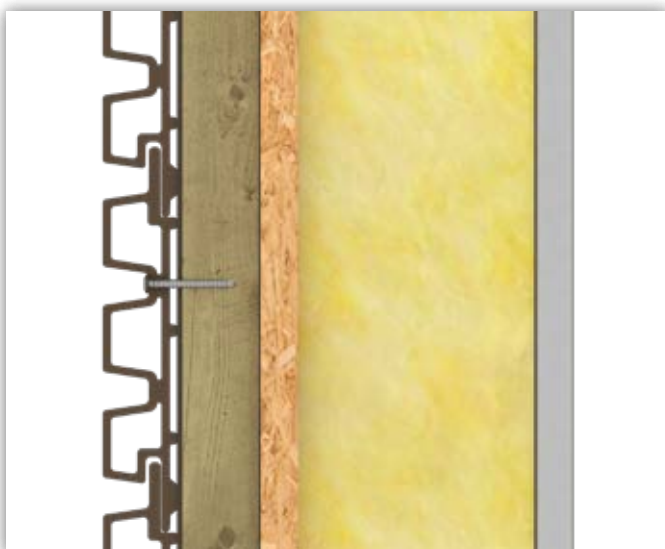
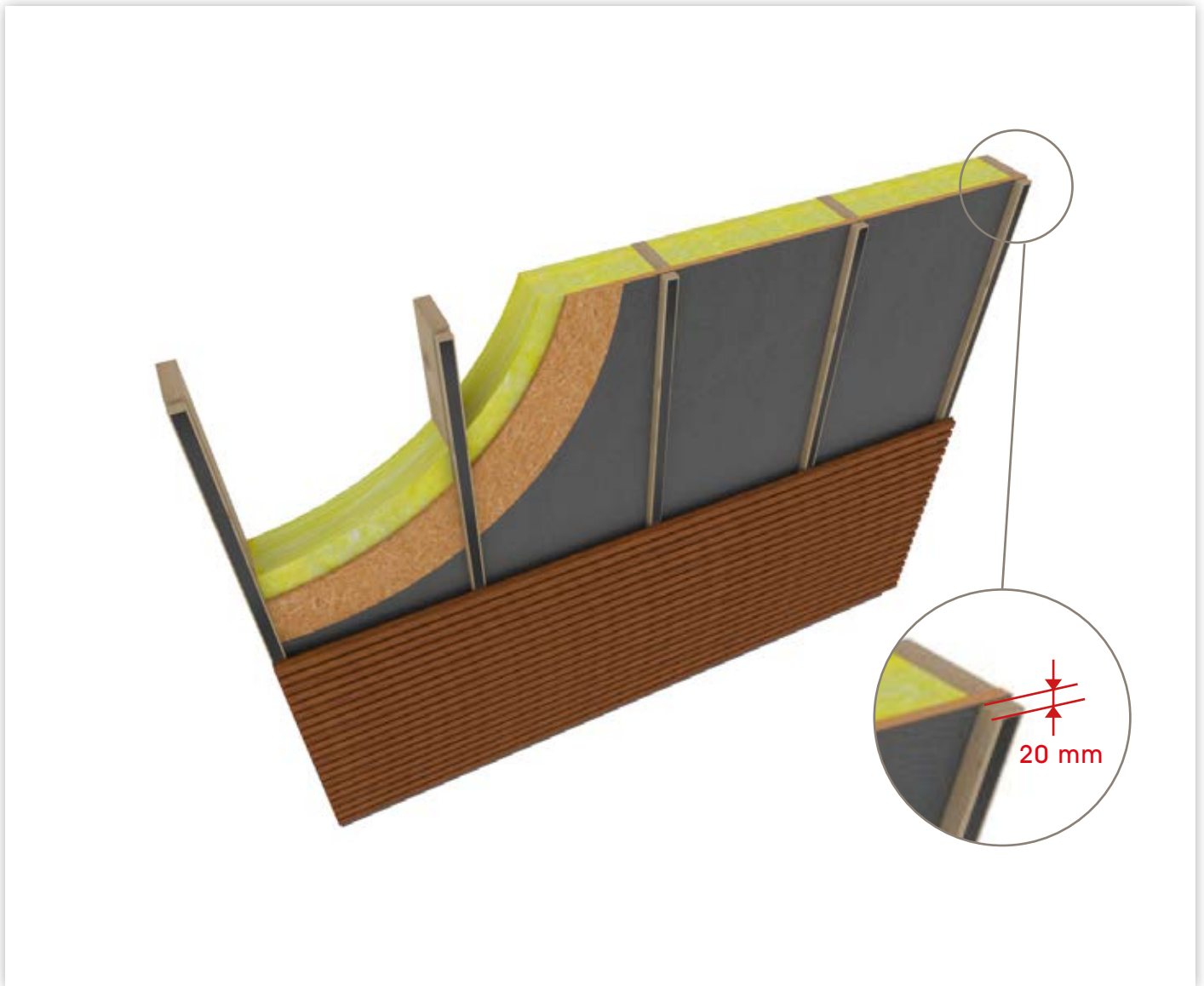

5 - INSTALLATIE VAN WEO 35® OP METALEN FRAME

5.1 - HORIZONTAAL

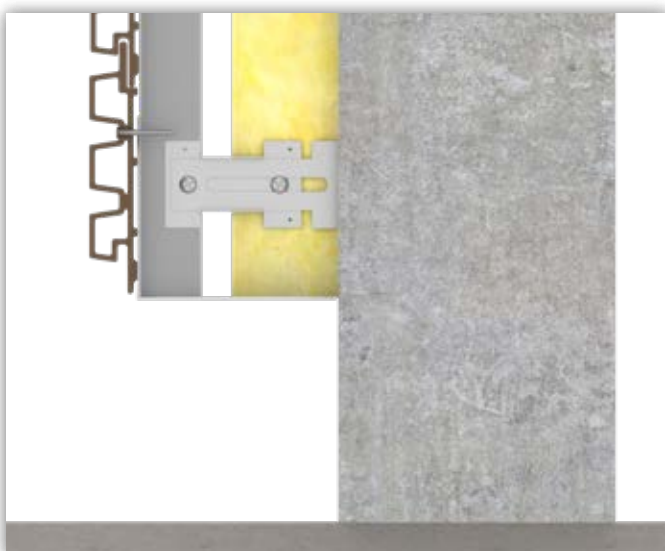
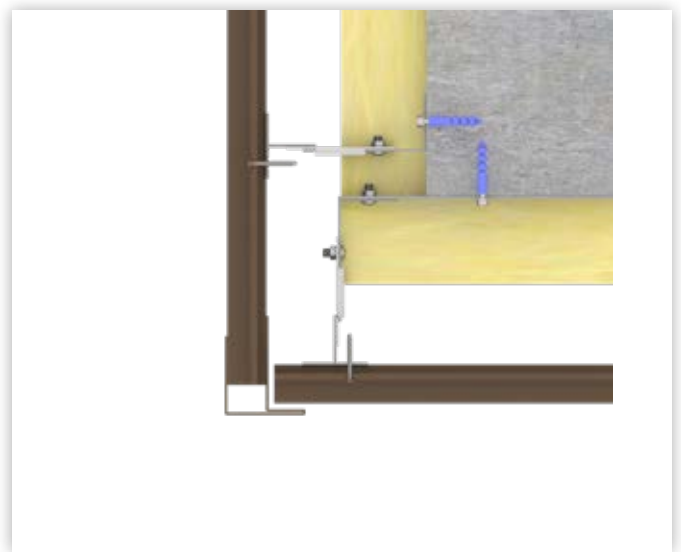
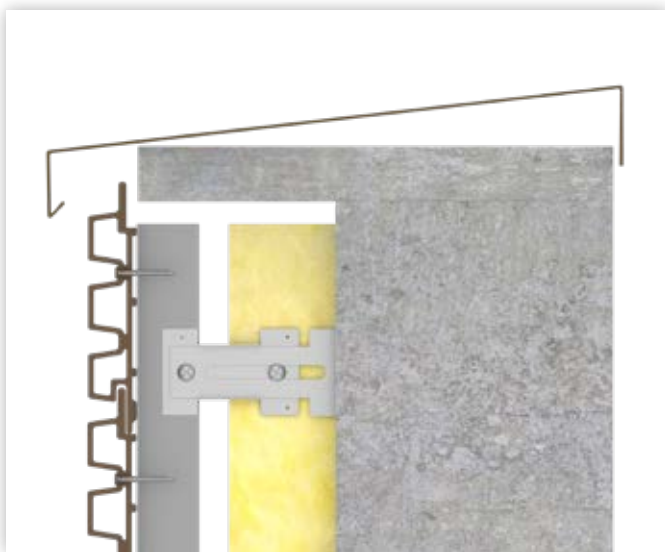
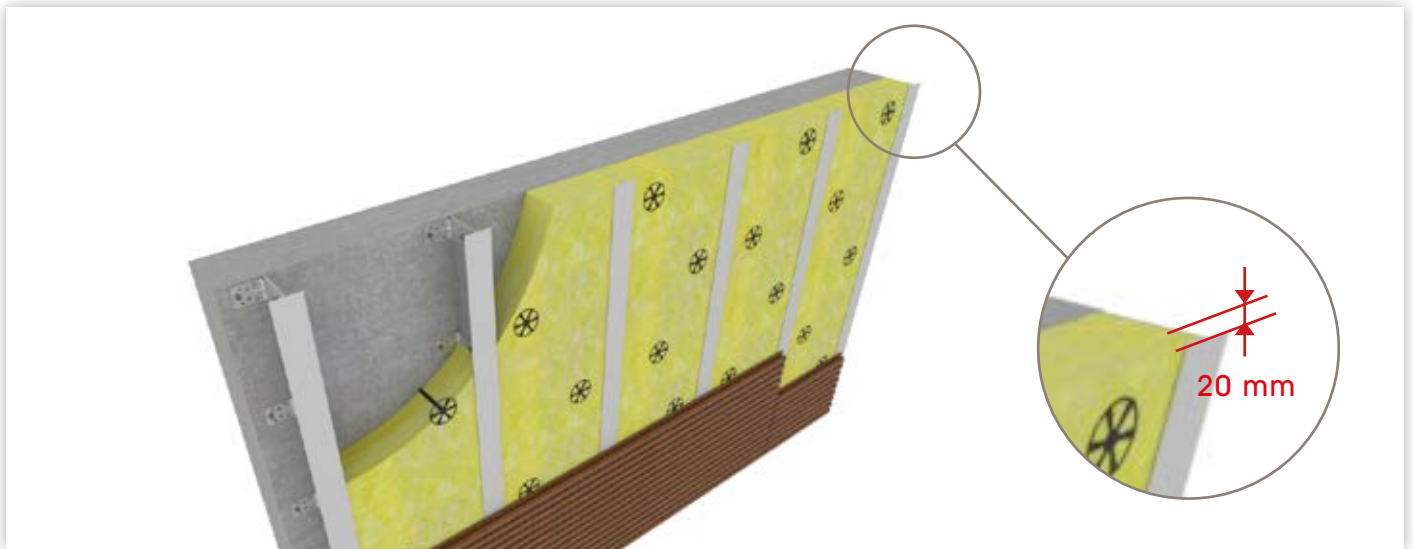

5 - INSTALLATIE VAN WEO 35® OP METALEN FRAME

5.2 - VERTICAAL

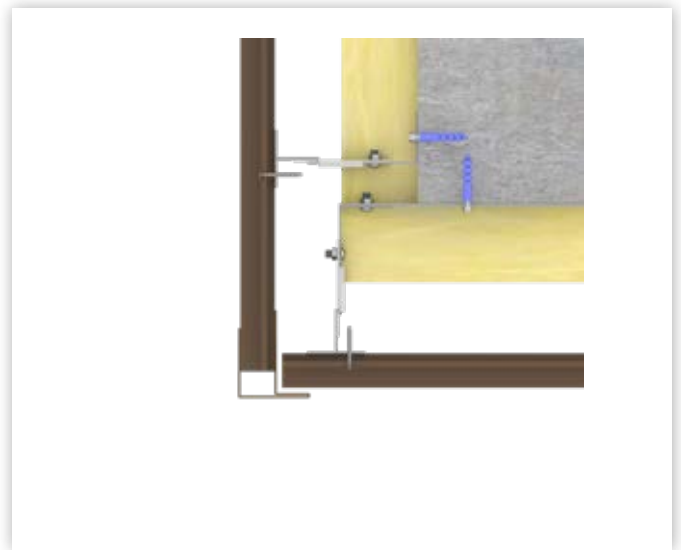
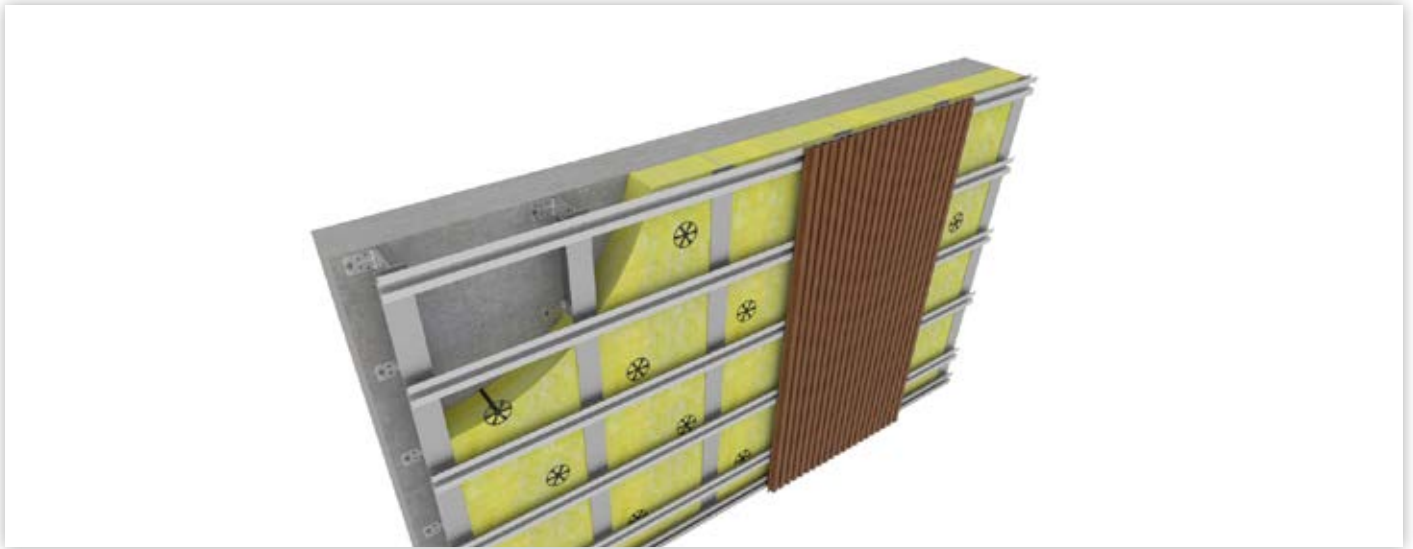

6 - INSTALLATIE VAN WEO® 60

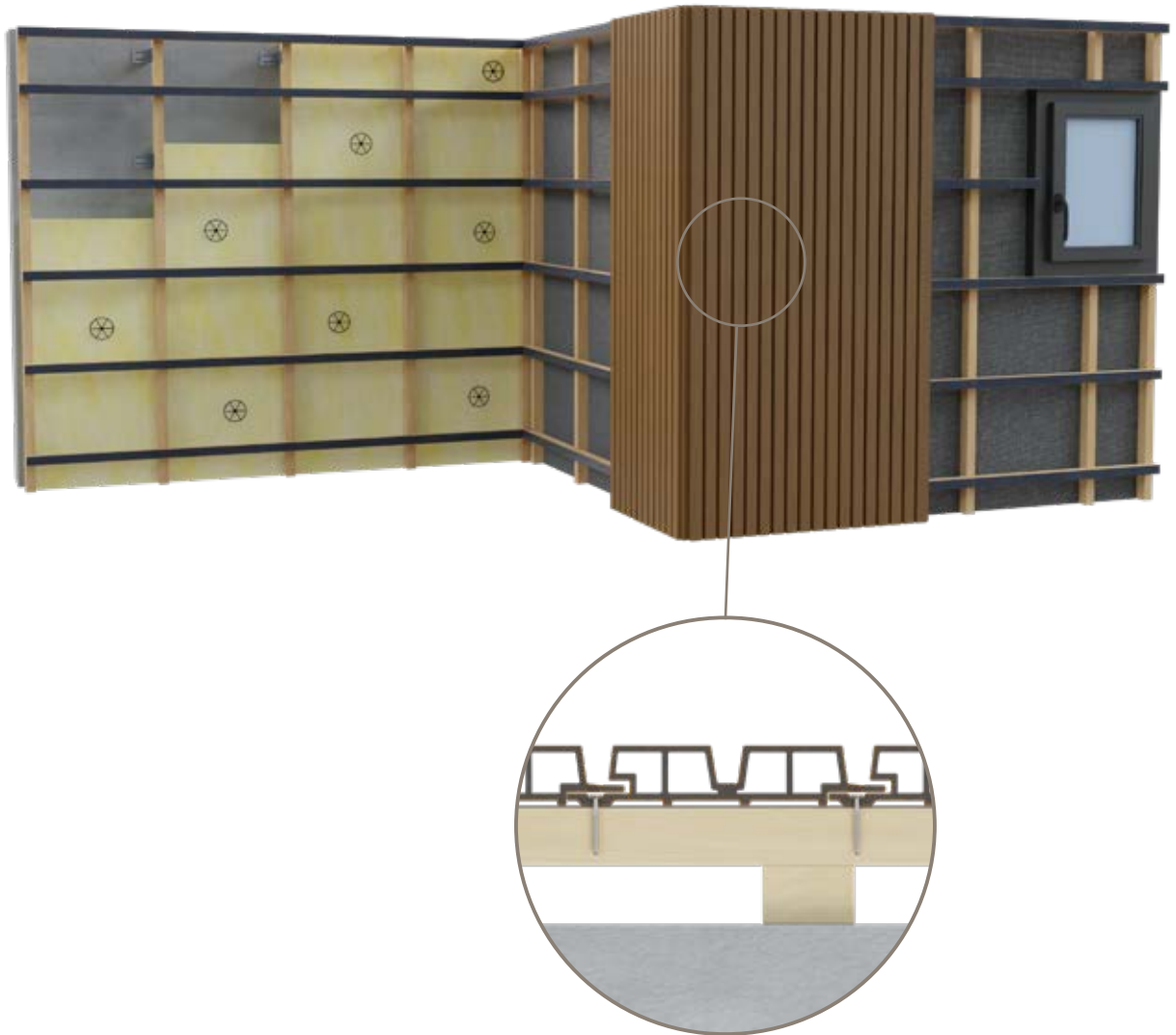

6 - INSTALLATIE VAN WEO® 60

6.1 - MONTAGE EN AFWERKING VAN WEO® 60

6.1.1 - VERTICAAL

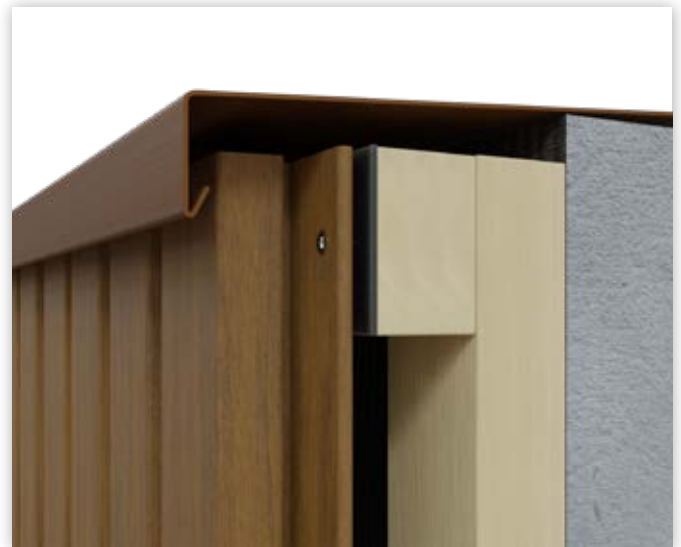

6.1.2 - HORIZONTAAL

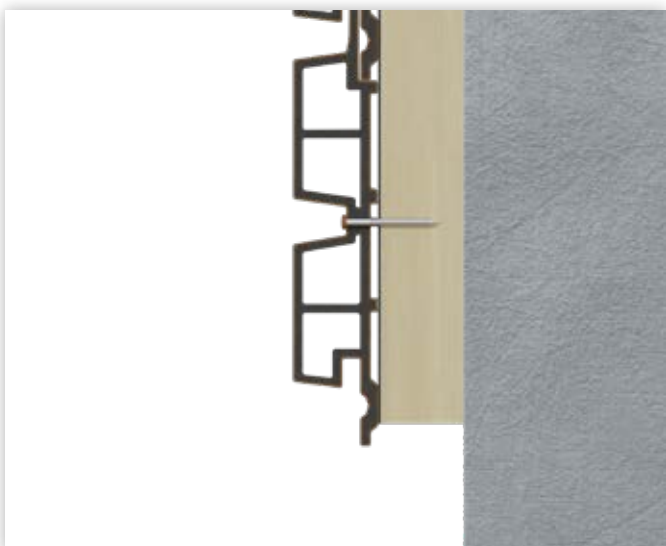

6 - INSTALLATIE VAN WE0® 60

6.2 - VERVANGEN VAN PLANKEN

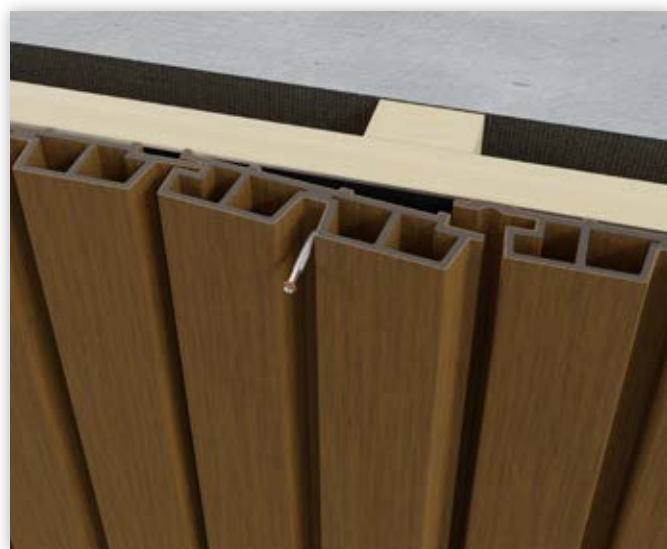
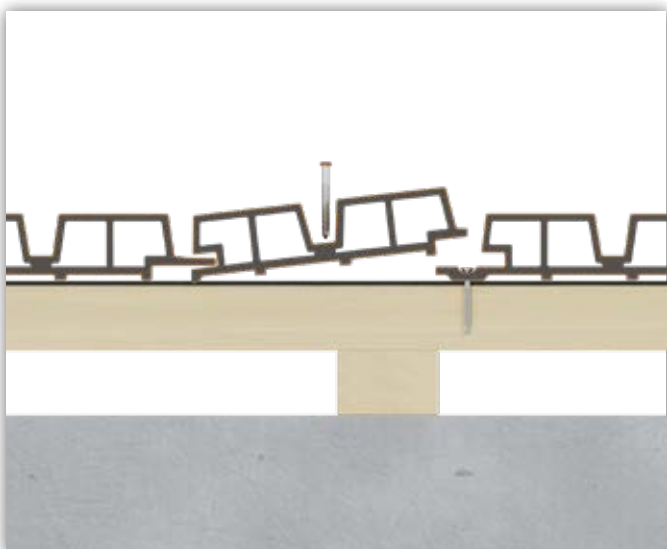
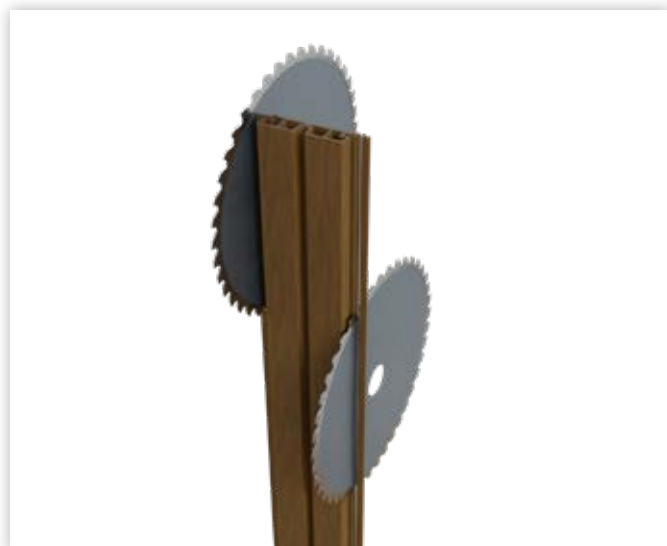

6 - INSTALLATIE VAN WEO® 60

6.3 - MIX VAN WEO® 35 & 60

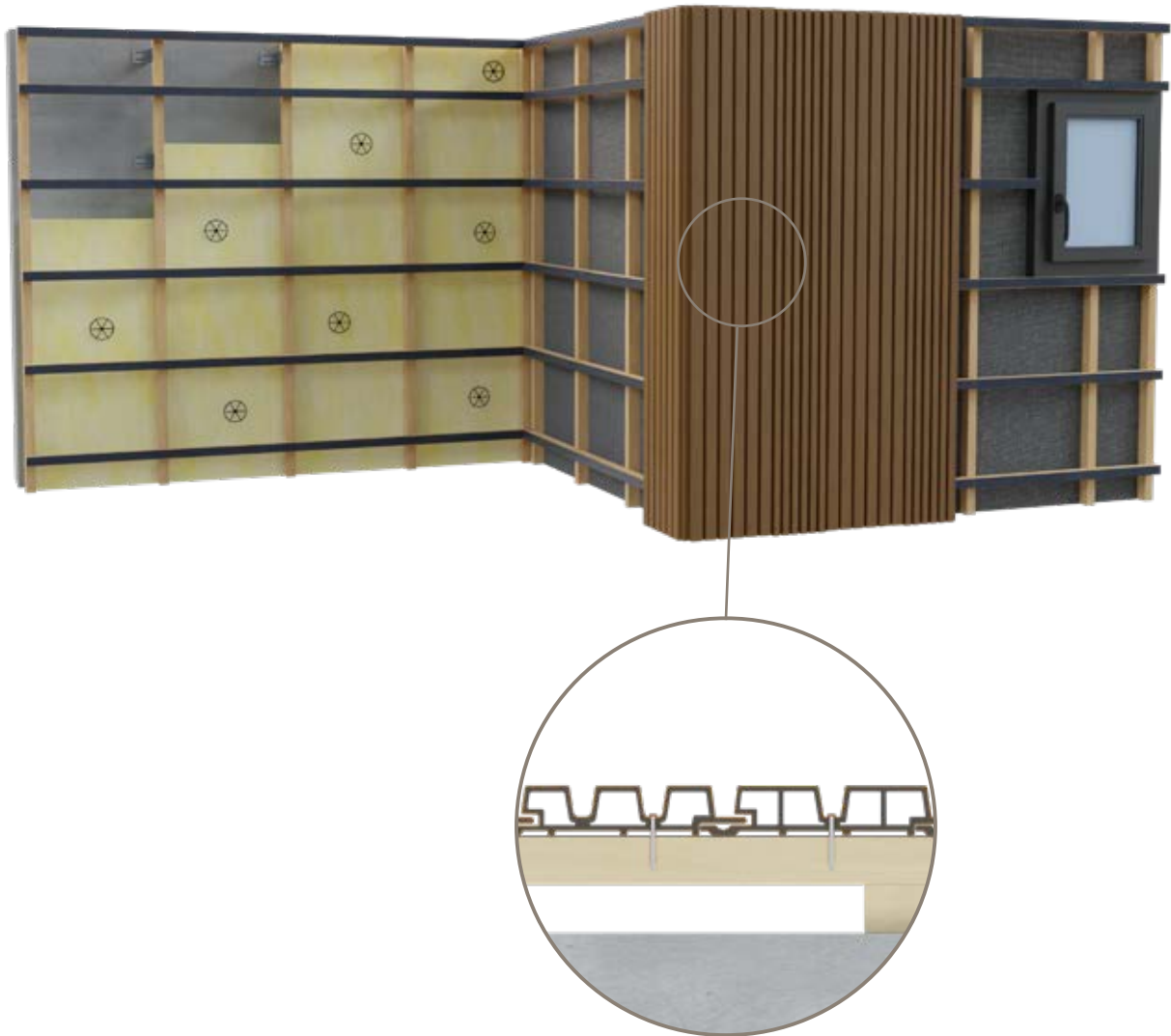

Fiberdeck[®]

fiberdeck.com